

LOG

THE KEEPER'S

VOLUME XXX

Celebrating 30 Years

NUMBER FOUR, 2014

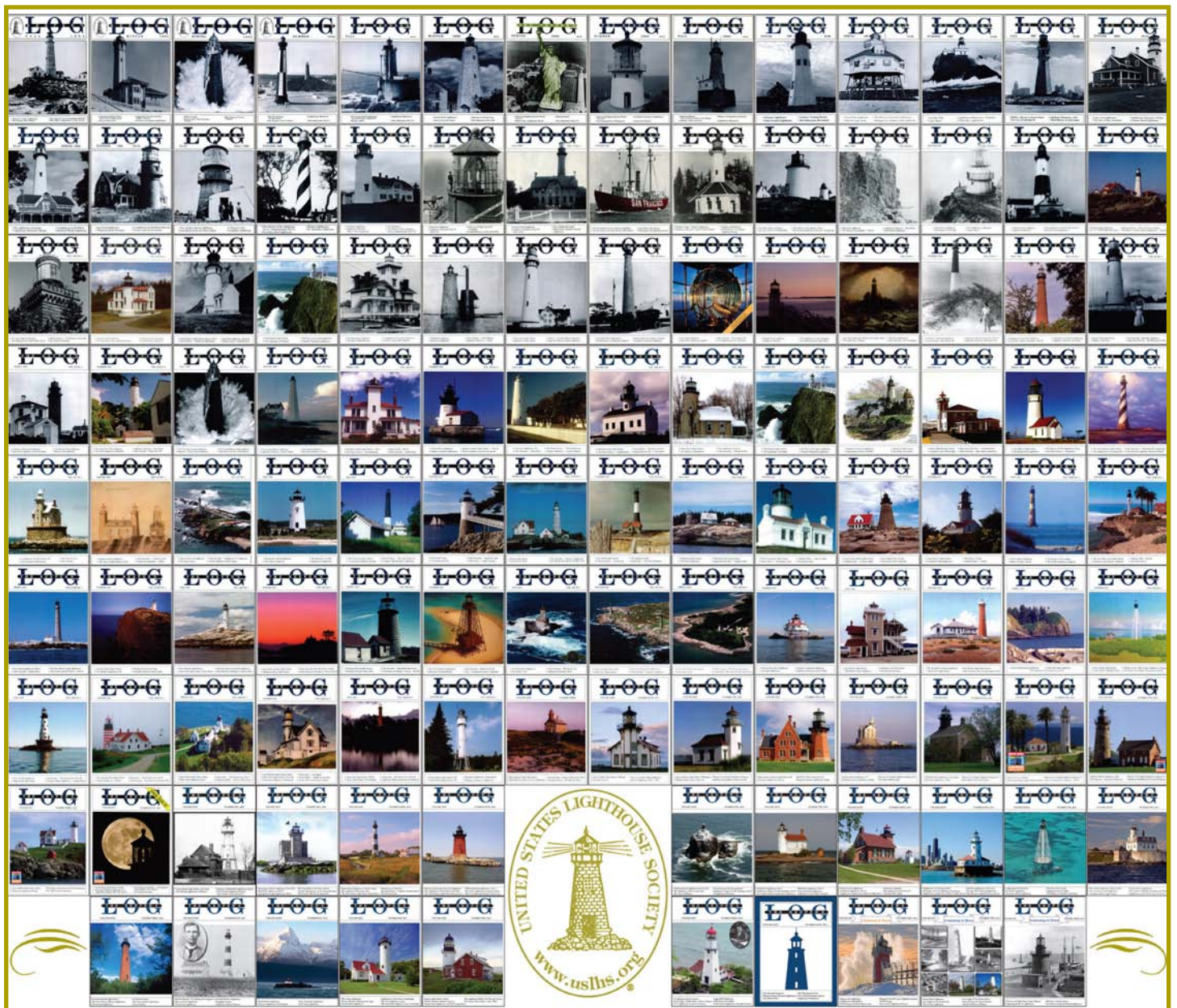

- History of the U.S. Lighthouse Society
- History of the U.S. Lighthouse Service

- History of Fog Signals
- History of the Life-Saving Service

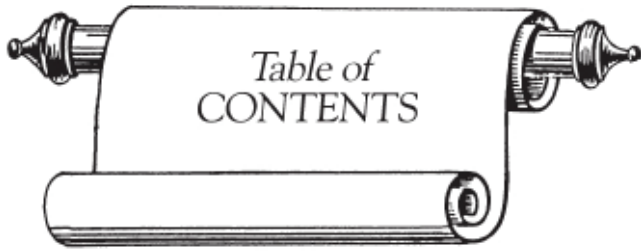

CELEBRATING 30 YEARS

- History of the United States Lighthouse Society 2
- The Founder's Story 8
- Thirty Beacons of Light 12

AMERICAN LIGHTHOUSE

- The History of the Administration of the USLH Service 23
By Wayne Wheeler

CLOCKWORKS

- The Keeper's New Clothes 36
By Wayne Wheeler
- The History of Fog Signals 42
By Wayne Wheeler
- Finicky Fog Bells 52
By Jeremy D'Entremont
- The Light from the Whale 54
By Mike Vogel

OUR SISTER SERVICE

- Through Howling Gale and Raging Surf 61
By Dennis L. Noble

U.S. LIGHTHOUSE SOCIETY DEPARTMENTS

- Notice to Keepers 68



244 Kearny Street, San Francisco. Courtesy of the City of San Francisco Museum.

Front Cover – *Keeper's Log* covers from Volume I No. 1 through Volume 30 No. 3.
Rear Cover – Monhegan Island Lighthouse, Maine, designed by Alexander Parris. Established 1850 reflectors (as seen in the drawing) were used in lantern until 1856, when a fresnel lens was installed. Courtesy of the National Archives.



THE KEEPER'S LOG

VOL. XXX NO. FOUR

November 2014

The Official Publication of the
United States Lighthouse Society,
A Nonprofit Historical &
Educational Organization
<www.USLHS.org>

The Keeper's Log (ISSN 0883-0061) is the membership journal of the U.S. Lighthouse Society, a resource management and information service for people who care deeply about the restoration and preservation of the country's lighthouses and lightships.

Jeffrey S. Gales – Executive Director

BOARD OF COMMISSIONERS

Wayne C. Wheeler	President
Henry Gonzalez	Vice-President
RADM Bill Merlin	Treasurer
Mike Vogel	Secretary
Brian Deans	Member
Tim Blackwood	Member
Ralph Eshelman	Member
Ken Smith	Member
Thomas A. Tag	Member

THE KEEPER'S LOG STAFF

Head Keep'—Wayne C. Wheeler
Editor—Jeffrey S. Gales
Production Editor and
Graphic Design—Marie Vincent
Copy Editor—Dick Richardson
Technical Advisor—Thomas Tag

The Keeper's Log (ISSN 0883-0061) is published quarterly for \$40 per year by the U.S. Lighthouse Society, 9005 Point No Point Rd. NE, Hansville, WA 98340. Periodicals postage paid at Hansville, WA and additional mailing locations. POSTMASTER: Send address changes to *The Keeper's Log*, 9005 Point No Point Road NE, Hansville, WA 98340. Phone (415) 362-7255. Use this address for all membership dues, inquiries and changes of address.

\$20.00 of all memberships provides for a subscription to *The Keeper's Log* for one year. All dues are tax deductible to the extent allowed by law. Copyright © 2014 by the United States Lighthouse Society. No portion of this magazine may be reproduced without permission of the U.S. Lighthouse Society.

The View From the Lantern Room

30 Years

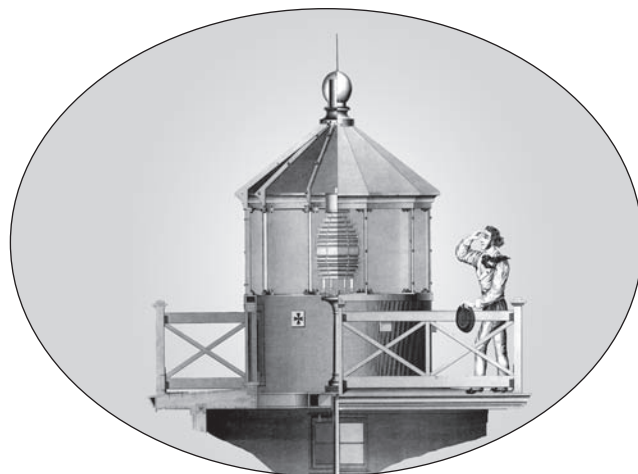

This year marks the 30th year of the Society and this issue the start of our 31st year.

A lot has transpired over those 30 years. What started out in my dining room in San Francisco as a quaint idea of a small Society has grown into a national organization, far beyond my initial expectations.

Working as head of the Coast Guard's Aids to Navigation office for northern California, I saw the interest the public had for light stations. At the same time, vandals were busy damaging those stations where we had removed personnel and automated. To remedy this situation, our office started the process of finding a creative use for our light stations. This protected the stations and our aids and at the same time made them available to the public in a variety of ways (tours, B & Bs, lodging for hostels). The practice spread throughout the Coast Guard.

This encouraged me to start a Society for those interested in their preservation. This germ of an idea mushroomed to the point that I resigned from the Coast Guard and never looked back. It's been a dream job and one of the most rewarding experiences of my life.

Our four initial pillars of the Society were to (1) create a quality quarterly journal, (2) create a comprehensive library and archive, (3) act as the central "clearing house," or point of information, for federal, state, and local agencies, regional and local nonprofit organizations associated with light stations (and lightships), and interested individuals, and (4) collect Lighthouse Service artifacts for a future museum.

In the back of my mind was the thought that just maybe the Society would grow to the point where funds would allow grants to worthy nonprofit organizations involved with lighthouse and lightship restoration projects. We have, over the years, contributed funds ranging from \$5,000 to \$20,000 to a few restoration projects, and we did restore the lightship LV 605 (about \$700,000 over 20 years). However, the dream, or goal, was to create a fund that would allow a consistent amount on a yearly basis to fund a project through a formal application process. Ideally the Society fund would be matched or augmented by some corporation as well as member donations, bequests, and funds realized from our educational tours.

This year we are announcing that our restoration fund has been created. Our first partner in this venture is the Lands End Company. How appropriate to have a company whose name signifies where our clients are located.

Additionally, the goal to have a national museum has, after 12 years, been realized. I will relate more on this project coming to fruition in the next issue.

Warm regards,

A handwritten signature in black ink, appearing to read "Wayne Wheeler".

Wayne Wheeler
President

HISTORY OF THE UNITED STATES LIGHTHOUSE SOCIETY



irst the United States Lighthouse Society stared Wayne Wheeler in the face. Then it came calling.

And then it grew up.

Formed 30 years ago this year, the nation's premier lighthouse organization found its president, rather than the other way around. It started with some routine lighthouse experiences for a young Coast Guard lieutenant, but it really blossomed when Wheeler instead became a civilian Coast Guard employee and was assistant and later chief of the Aids to Navigation Branch for northern California, with an entire office wall of bookshelves loaded with Lighthouse Service technical manuals, reports to Congress, and files.

And the calling? Most of the inquiries the Coast Guard's public affairs staff was receiving involved lighthouses—and, well, Wheeler had the books.

"This is where it starts," the long-time Society president recalls.

The books facing Wheeler had come from as far back as when the lighthouse service first came to the West Coast. "We had all the reports to Congress, 1910 to 1939, bulletins, engineering books, ATON instruction manuals, medical practice for the Lighthouse Service, Arnold B. Johnson's 1890 history of the Lighthouse Service, radiobeacons, plus we had files on all the manned lighthouses in northern California," he said. He started answering the calls and letters about those lighthouses, and found "it was fascinating. I just loved it."

That was more than 30 years ago, and the idea of a society hadn't yet taken shape. But it was stirring, and it got a boost when Wheeler's reputation headed east to historic Fort Sumter. In 1981 a National Park Service official seeking information at that national monument contacted Wheeler, who recalls that "the letter started out, 'I understand you're a lighthouse expert.'"

"I took it home and showed [my wife] Sally, and said, 'This guy thinks I'm an expert! Isn't that funny?'" he said.

Then a colleague researching Gulf of Mexico lighthouses (because "nobody's done the Gulf,") stopped by to discuss his work at a local maritime library. "He and I got to talking about it, and I thought, 'This is fascinating stuff!' and I put together a slide show."

A presentation on lighthouse history soon followed at a middle school and Bay Area yacht clubs, and "after that the phone just rang off the hook." Lots more talks followed for Wheeler, and "about 1982, I came home one day and said to Sally, 'Boy, there's a lot of lighthouse enthusiasts out there. They ought to get organized.'"

Bingo. Sort of.

"It was going to be the California Lighthouse Society," Wheeler said. He met Burr Henneman, a friend from the Point Reyes Bird Observatory, for lunch in a park one day and was told to stop thinking so small. "Right then, I changed it to United States Lighthouse Society."

From the start, the new USLHS had standards and goals: a quality quarterly magazine; a lighthouse research library; a central communications hub for all federal, state, and local agencies, historical societies, and nongovernmental organizations interested in lighthouses; and the collecting of artifacts for an eventual lighthouse museum.

Wheeler made a flyer available at his talks, seeking interest but telling people not to send money. With that and the continuing talks, word spread. People sent friends and relatives the flyers, all over the country.

"Within a year I had 850 names from all over the United States," Wheeler said, and it was time to apply for IRS tax-exempt status. Information later was sent to 450 maritime museums and large historical societies. The next step was a plea to every newspaper in the country with a circulation of more than 60,000—190 of them—and about 30 boating and general magazines that might be interested, seeking a notice or free ad. A mention in *Playboy* elicited 190 responses, and even one membership from a guy who noticed it while throwing out old magazines 10 years later.

The United States Lighthouse Society was up and running. Sort of.

"My dining room table was my office for two years," Wheeler recalls. "It was just stuffed."



Wheeler in his USCGR office in October 1983. Photo courtesy of Wayne Wheeler.

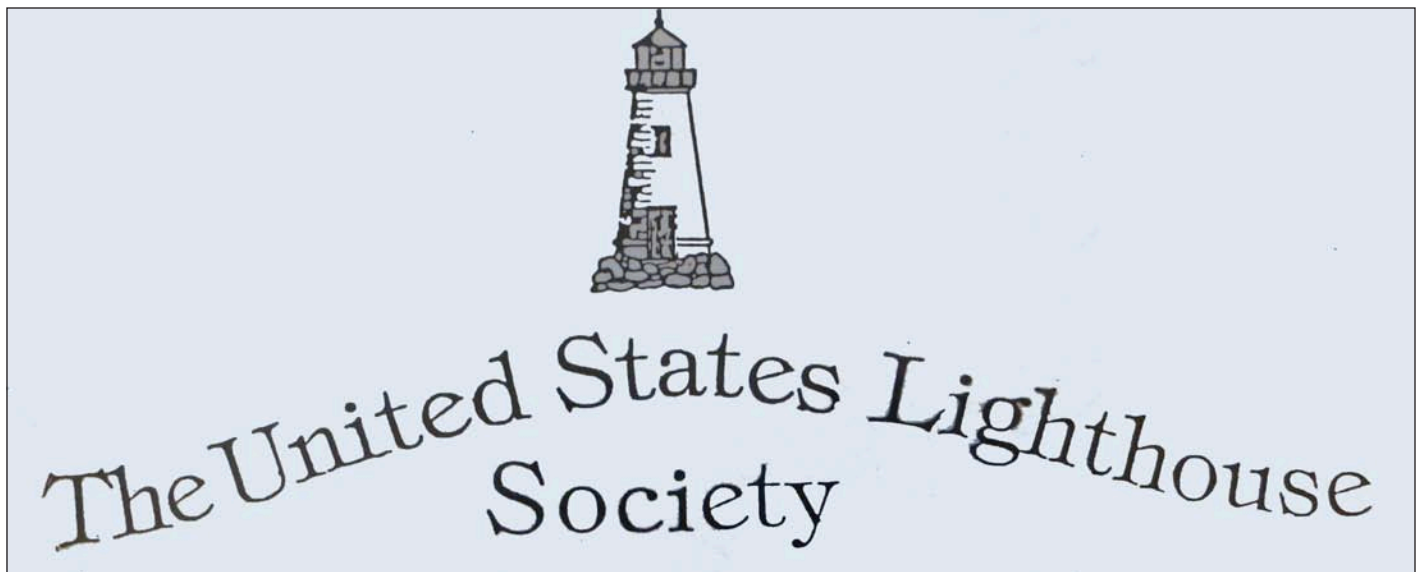

The first (above) and second (bottom of page) letterhead of the United States Lighthouse Society.

With Sally Wheeler signed on as board secretary and Bay Area friends rounding out the first board of directors, the Society received its state and local nonprofit status in early 1984. Former Navy commander and then-machine shop owner Walter Fanning, raised at Yerba Buena Lighthouse as the grandson of lighthouse keepers, was the first vice president, and Pete White took time from writing a book on the Farallon Islands to serve as treasurer. Butch Skaar came on the board after working as an early volunteer, and later would serve for years as secretary. Mrs. Wheeler researched funding agencies, and after a year the Society began to receive grants, allowing for the purchase of an office computer and other office furnishings that added to the clutter in the family dining room. Wheeler left the Coast Guard in 1987 to devote his full efforts to the Society. "It was membership that built the Society," Wheeler says.

Wheeler had collected a number of lighthouse books and other historical material over these first three years and by mid-1985 the Society began to develop its archive. Books and other documents were actively sought from across the country, and the Society began to purchase lighthouse-related materials. It also began collecting lighthouse slides and photographs; the Society's annual photography contest eventually brought in thousands of slides and prints of lighthouses.

Also around 1987, the first of many Society tours took a group of members on a one-day visit to lights in the San Francisco area.

By the end of 1985, membership was well past 2,000 individuals. The letterhead was finalized with the address of Wheeler's home as the official mailing location.

Soon, planning was going on for the Society's second tour: a three-day trip that also stayed close to home. Attendance at this San Francisco area tour was significantly higher, though, indicating that there was a strong desire for such trips. After those tour pilot efforts, planning was increased and major domestic lighthouse tours were planned for future years, with the first extended tour heading to Maine. Eventually the tours would cover the United States and branch outward to foreign lands.

On March 17, 1986, the Society was honored to receive an award from the Department of Transportation for historic preservation. By this time the Wheeler dining room was overflowing with files, the archive, merchandise for the Keeper's Locker, and many other items. Planning began for a move to a real storefront office. The Society was able to find such a location at 964 Chenery Street in San Francisco, and it moved there during the summer of 1986.

Even while the office still was in Wheeler's home, the fledgling Society received an offer of the donation of LV 605, a lightship that had been used on two stations and in its last active years as a station relief vessel for northern California. The donation stipulated that the vessel emblazoned with the name RELIEF be restored and

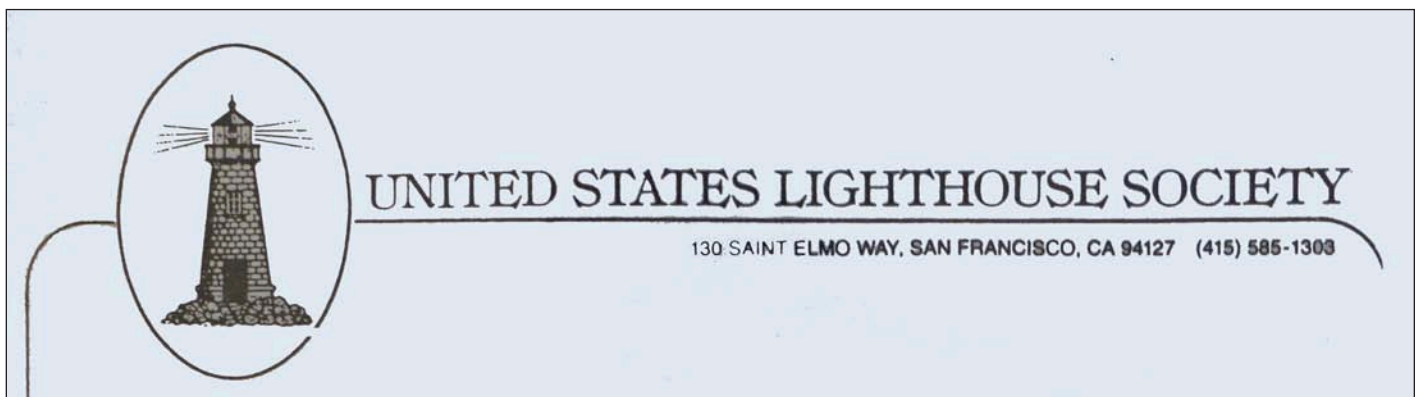



Above: The first home of the United States Lighthouse Society – Wheeler's house in San Francisco.
 Below: The front entrance at 964 Chenery Street, San Francisco.



maintained somewhere in the San Francisco area. Negotiations immediately began to find a proper location and to find individuals who would be willing to volunteer to restore the vessel.

In February of 1987, the transfer of LV 605 to the Society was completed, and the ship was brought into the harbor in adjoining Oakland. Once it was moored, a group of volunteers began the arduous task of restoring the ship to its original glory. The first esti-

mate was that the restoration would take just two years to complete. Actually it would be nearly 14 years before the ship was fully restored.

All this activity placed a great strain on the Society's resources, and for the first time an office manager was hired. Tanja Rabbitt became the first paid full-time employee of the Society in the spring of 1988.

Things were moving fast, membership continued to grow, and the office at Chenery Street could no longer hold the workers, archives, storage, and growing collection of lighthouse artifacts. The decision was made to move into larger quarters located in down-

town San Francisco at 244 Kearny Street. This new facility was the fifth floor of a small office building, with offices, an open area for visitors and the archive, and room for storage.

This new office would be the Society's home for the next 10 years.

There now was room to grow, and the archive reached more than 1,000 volumes.

As the Society grew, so did the requests for assistance from the Society. In 1989 Wheeler was asked to give a keynote speech at the restoration celebration for the lighthouse in Key West, Florida. In that same year the Society petitioned Congress to designate August 7 as National Lighthouse Day throughout the country. August 7 was chosen because that was the date



The front entrance at 244 Kearny Street, San Francisco.

when all lighthouses had originally come under control of the U.S. government with the creation of a federal lighthouse service in 1789.

The year 1989 was the bicentennial year for lighthouses, and in September the United States Lighthouse Society held Lighthouse Bicentennial Week festivities in Newport, Rhode Island—a memorable event for those who participated and attended, although the threat of an approaching hurricane kept the numbers down.

Back on the West Coast, though, things still kept looking better. The Society hired an additional person in the office, and several volunteers were at work there as well. The archive continued to grow and the additional funds being received allowed for the purchase of a number of rare lighthouse books. Restoration work also continued on LV 605. This work turned out to be far more extensive than originally thought. The volunteers decided they wanted to completely restore the lightship, and that added thousands of additional hours of restoration to the mix. In 1990 their work was recognized when LV 605 was designated a National Historic Landmark. Luckily, early in 1991 the Society received a \$14,000 grant toward redoing the underwater portion of the lightship hull.

In the summer of 1990, the United States Lighthouse Society had been the host organization for a Lighthouse Commemorative Stamp unveiling and the U.S. Postal Service prominently identified the Society on each booklet of lighthouse stamps. This publicity led to a large increase in requests for memberships, sending the organization to a record of more than 7,000 members. With that growth, and additional revenue, the Society was able to produce a *Keeper's Log* with a full-color front and rear cover as the summer issue of 1991 (inside, mostly-color issues would debut in the issue for spring, 1996). Later in 1990 a television documentary crew arrived and filmed the

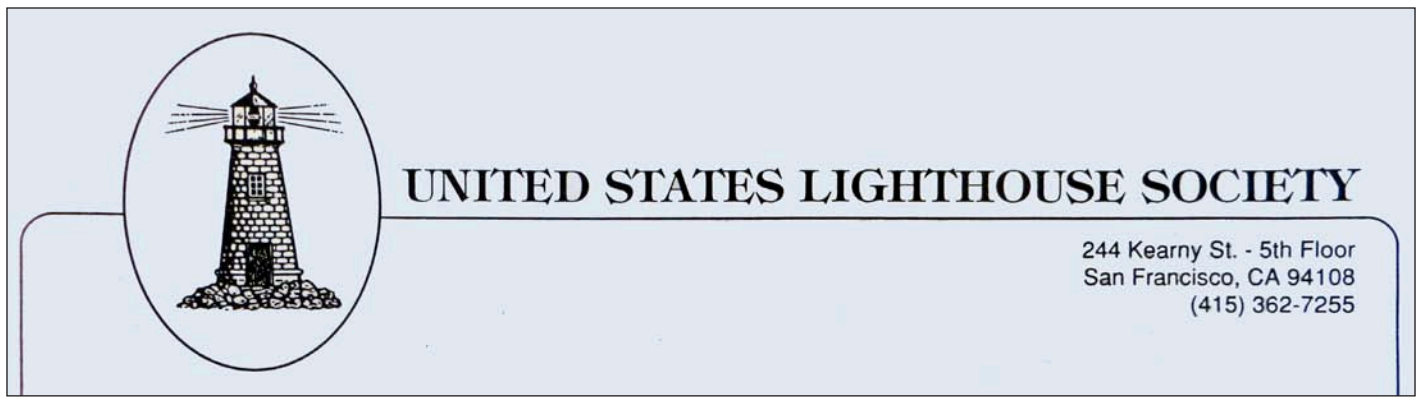

The third letterhead of the United States Lighthouse Society.

Society's lightship restoration work for a Public Broadcasting Service special. Planning was also underway for the Society's first international lighthouse tour, a visit to Russian lighthouses that began on August 17, 1992.

In the spring of 1994, the Society developed another new concept: a Passport Program, distributing a booklet similar to an official governmental passport and encouraging visitors to participating lighthouses to ask to have their passport rubber-stamped and leave behind a one-dollar donation to the local lighthouse group. Filled passports earn collectors Society recognition awards; released in 1995, the program has proven immensely popular.

By now, lighthouse activities were now taking place across the country and several new regional lighthouse organizations were being formed. Interest in historic lighthouse preservation was increasing, and there was a need for some guidelines and methodology. Your Society joined with the U.S. Coast Guard and the National Park Service to create a comprehensive historic preservation program for the Coast Guard in early 1996. Lighthouse restoration and preservation continued to grow, and it was determined that a *Lighthouse Preservation Handbook* was needed. The Society again joined with a few other agencies and groups to develop this manual during the fall of 1997.



Kent Weymouth, a Society member doing research in the archive.

The Society had long promoted the idea of a National Lighthouse Museum. In 1998 the Society participated in a national steering committee to see if there was enough interest in the lighthouse community for such a museum and, if so, to determine a proper site to build it (see the accompanying article on lighthouse preservation milestones).

In 2000 the Society attended an International Lighthouse Conference held in Nova Scotia and made a number of presentations while there. Later that same year the Society was one of four partners working with Congress in the development of the National Historic Lighthouse Preservation Act of 2000. Society leaders and members would attend and present at many other national conferences through the years, including events in St. Augustine, Washington, Norfolk, San Diego, Baltimore, Boston, and Wilmington, North Carolina.

Finally, in June of 2002, after 14 long and arduous years, the Society's lightship *LV 605* was fully restored and opened to the public at a cost of nearly a million dollars in grants and volunteer labor.

The Society's first website was developed during the latter part of the year 2002 and was placed in operation at the start of 2003. While the first website worked, it was difficult to use and lacked visual interest. It soon was decided to completely update the website and add a number of new areas of lighthouse information, and that was completed in the first half of the next year.

In the spring of 2003, the Society received the Phoenix Travel Award for its tour program and the many and varied tours it had undertaken up to that time. On May 1, 2004, the Society and its Chesapeake Chapter took over the restoration of the Thomas Point Shoal Lighthouse in Maryland. While the Society does not own this lighthouse, the Chesapeake Chapter began the complete restoration of the lighthouse as part of a regional partnership with the eventual goal of having the public be able to visit the offshore lighthouse.

In the fall of 2004, Wheeler and Ken Black were the first recipients of the Ross Holland Award, an infrequent honor given by the American Lighthouse Council to those who have made the most significant contributions to the lighthouse community.

During the summer of 2005, Wheeler decided to retire from his day-to-day operational activities with the Society. Jeff Gales was hired as executive director of the Society and took over its day-to-day leadership, with Wheeler remaining as a deeply involved president of the board of directors.

The Society has continued to improve and maintain its presence in the lighthouse community. However, in 2008 the Society moved for the



UNITED STATES LIGHTHOUSE SOCIETY

9005 Pt. No Point Road NE
Hansville, WA 98340
Phone: 415-362-7255
Fax: 415-362-7464
www.uslhs.org

Fourth and current letterhead of the United States Lighthouse Society.

fourth time to its current headquarters at Point No Point Lighthouse in Hansville, Washington, not far from Seattle. This put the group's headquarters in a light station, its first co-location with a lighthouse.

In the fall of 2008, the Light Lists feature was added to the USLHS website. This module allows the retrieval of the history of a lighthouse through its various listings across time in the Light Lists. The module contains vast amounts of data and had to be compiled over time. We are still working on updates to this data and trying to complete the collection of lists.

Despite the website updates, the Society in 2009 was lagging behind the times with its use of social networks. On that March 31, it joined Facebook and began regular updates to its timeline. In September of 2009, the Society website was greatly improved when a new module called "The Community" was released. The

Community, developed by Gary Riemenschneider, allows members to record their lighthouse tours and other visits. This module has become very popular and many members use its services.

Throughout the years the Society's Passport Program had continued to grow, and by 2012 thousands of members and others had joined. It was decided that it had become so popular that a Passport Club was created and a software module was placed onto the Society's website for Passport Club purposes. As a part of this effort, several members volunteered to carefully go over the Passport information and bring it fully up to date.

Website improvement is an ongoing project and continues to this day. Other updates still continue, with a major redesign and expansion due soon.

While the virtual world presence continued to increase, other work



The former keeper's dwelling at Point No Point. Society headquarters is on the right.



The U.S. Lighthouse Society Board of Directors, their spouses, and guests at Egmont Key Lighthouse. Left to right: Dede Smith, Mike Vogel, Brian Deans, Ken Smith, Elinor DeWire (guest), Ralph Eshelman, Evelyn Eshelman, Wayne Wheeler, Madeline Blackwood, Bill Merlin, Sally Wheeler, Alice Merlin, Jeff Gales, Phyllis Tag, Tom Tag, and Tim Blackwood. Not pictured, Henry Gonzalez.

in the real world also expanded and drew national recognition. On January 12, 2009, the United States Lighthouse Society was designated as a “Preserve America Steward” by First Lady Laura Bush for its exemplary volunteer efforts in restoring the Thomas Point Shoal Lighthouse.

When the Society moved to the Point No Point Lighthouse, it took over the restoration of the lighthouse, former keeper’s dwelling duplex, and various other buildings. Restoration projects began with the keeper’s workshop in 2009-2010, continued with the lighthouse and oil house in 2011-2012, and work is currently in progress on the keeper’s duplex which should be completed by spring, 2015.

Later in 2010 the Society announced the creation of the Lighthouse Guardians Historic Trust through the generosity of a member who had left the Society a donation in her will.

Over the years the lightship LV 605 continued to be a popular attraction, and minor restoration work continued to maintain the vessel. In late 2012 the Society was approached by the Anchor Program in San Francisco, which wished to take over the ship and use it as part of its marine trades education program while still making it available to the Society for tours. The details were worked out and ownership of the vessel was transferred to the Anchor Program that fall.



Current Society office staff and volunteers. Left to right: Dick Richardson, Jeff Gales, Melissa Eck, Skip Sherwood, Mary Lee Sherwood, Rich Gales, and Marie Vincent. Photo courtesy of Jeff Gales.

Through the decades, the Society also has benefitted from the skills, time and talent of staff members and key volunteers, including Wayne Wheeler, Tanja Rabbitt, Phyllis Chaix, William Morrison, John Thomas, Rusty Nelson, Marie Shaft, Linda Menges, Steven Cruz, Connie Jo Crowder, John Abrams, John Byrne, Jack Merk, Denise Kendall, Connie Kendall, Lisa Chinn, Marion Di Silva, Kikelomo Adedeji, Shannon Ricks, David Snyder, Barbara Talley, Thomas Tag, Jeff Gales, Melissa Eck, Rich Gales, Lynda Winslow, Lisa Jones, Dolores Thacher, Marie Vincent, Toni Rosatti, Chad Kaiser, Mary Lee and Skip Sherwood, Megan Bradley, Mary Borkowski, Dick Richardson, Peter Williams, Katherine Klint, Rina Guevara, and Gary Riemenschneider.

Even with the rough national financial times of the last few years, your Society has been able to maintain its balance and to grow and support new lighthouse projects and initiatives. A lighthouse preservation grant program now has been started to increase ongoing support of local lighthouse restoration efforts. This has only been possible through the strong efforts of our membership, volunteers, and staff. We are happy to report that in this our 30th year we continue to grow and look forward to many significant advances in our ability to assist our members with their interest in lighthouses.

Chapters of the U.S. Lighthouse Society

Over the years several chapters of the U.S. Lighthouse Society were founded across the country. Some, the Massachusetts Chapter for example, are only memories. Others, such as the New Dungeness and New Jersey chapters, morphed into independent lighthouse societies in their own right. The largest (and arguably most active) chapter, the Chesapeake Chapter, began as the Virginia Chapter and is celebrating its 25th anniversary in 2014.

The current chapters of the Society are the following:

Chesapeake Chapter

President: Tony Pasek
P.O. Box 1270, Annandale, VA 22003-1270
www.cheslights.org

Friends of Point No Point

President: Shelley Douglas
P.O. Box 223, Hansville, WA 98340
www.pnplighthouse.com

Long Island Chapter

President: Carol House
1100 Shames Drive, Suite 205, Westbury, NY 11590
www.lilighthousesociety.org

Pacific Northwest Lighthouse Group

(formerly the Oregon Chapter)
President: John DeHass
P. O. Box 940, Fairview, Oregon 97024
www.pnwlg2014.org

The Founder's Story

It all became real on Thanksgiving Day 1984.

Wayne Wheeler knelt in the garage of his San Francisco home with a pile of cardboard boxes, and the emotions washed over him.

In the boxes were the first issue of the *Keeper's Log*, just driven 300 miles from the publisher by a salesman. They were also the first tangible evidence that the United States Lighthouse Society Wayne had just founded was, in fact, real.

"I was crying," the head keeper recalls. "It was the most incredible sight to see that, see all these boxes of magazines."

That first *Log* would wait in the garage just a bit, while he learned the rules and regulations for second and third class mailings. Wayne and Sally Wheeler weren't going to be doing much at-home celebrating that Thanksgiving, anyway—the dining room was more stuffed than the turkey, with books and files and everything lighthouse Wayne had gotten his hands on.

Looking back, for Wayne, provides some perspective. Sally, he says, was a mainstay.

"She put a lot into it," he adds. "She was the secretary for years until I started getting paid and I thought that wasn't right and she stopped. I was absolutely driven. I don't know how the hell she put up with me."

The path to the United States Lighthouse Society was a long and sometimes difficult one that took Wayne only incrementally to lighthouses and the sea.

Born in Buffalo and raised in Cortland in mid-state New York, Wayne joined the Coast Guard out of college in the early 1960s. As a 23-year-old junior officer, he sought assignment to Hawaii but got posted to a buoy tender in Alaska instead. On duty there from 1963 through 1965, he worked his first lighthouses.

"We had four light stations to provide logistics to. Every two weeks, we went to these four lighthouses and we took them mail, food, 15 movies from the Navy movie exchange program, and once in a while I had to go aboard and inspect the station or give



Wayne Wheeler, executive officer, 1969, Honolulu. USLHS archives photo.

a test for some kid making the next grade," he says. "These stations, like Eldred Rock, you just walked around the rock. There wasn't much going on."

After a few months as an admiral's aide in southern California, Wayne eventually transferred to the Coast Guard's District Headquarters in Cleveland and found himself reviewing buoyage for the Aids to

Navigation office. "I did get to inspect light stations and buoy tenders," he said. There was a turn at the ATON school in Connecticut, and duty once took him to inspect the lighthouse at Tibbets Point on Lake Ontario, where he encountered a veteran civilian keeper.

"I was a j.g. (lieutenant junior grade) and I knew everything there was to know,"

Wayne chuckles. The keeper pointedly noted a pile of socks kept handy so visitors – including the inspector – wouldn't sully the ladders and decks. Wayne started inspecting the lens but quickly picked up "bad vibes" from the silent keeper, "and I immediately realized I didn't know crap, compared to this guy, and I just said, 'everything looks great, Cap,' and I went down the stairs and in the car and gone." But, he adds, "mostly it was a desk job."

Next came an assignment as the executive officer of a Hawaii-based buoy tender, reporting aboard in Japan. After visiting South Vietnam, the Philippines, and Guam, the ship made home port in Honolulu. When the ship was restationed to Alaska, he remained in Hawaii as the base executive officer, doing monthly inspections at places like the Makapu'u Lighthouse. From 1969 to 1972, Wayne was assigned to the Loran branch at Coast Guard headquarters, preparing budget documents to send to Congress. While there, he also was the Coast Guard representative to the National Navigation Plan implementing GPS. From Washington there was a final reassignment to the vessel traffic system office in San Francisco, where he would later resign from the Coast Guard. Wayne took a year off, met and married Sally, and then learned of a civilian job available at the Coast Guard's bridge section right back in the ATON office. A year later, the civilian assistant chief of the ATON office resigned and Wayne was selected for the position.

Ensnared in an office with lighthouse reports, manuals, and publications gathered through the years from all over the West Coast, Wayne started answering all the calls and the letters that were dropped in his in box. Soon, he was hooked on the research and the lore of lighthouses. Slide-show presentations at yacht clubs, schools, and historical societies followed. The Society still has the scrapbook he kept of all the talks up and down the coast.

Eventually, he put his college degree in advertising design to work and sketched out a magazine and brochures, plotting out all the sections the magazine would have. Informational flyers went out, batches of them to organizations and publications. He also applied for nonprofit status, and Sally went to the Foundation Center and found that of 40,000 philanthropic organizations, only

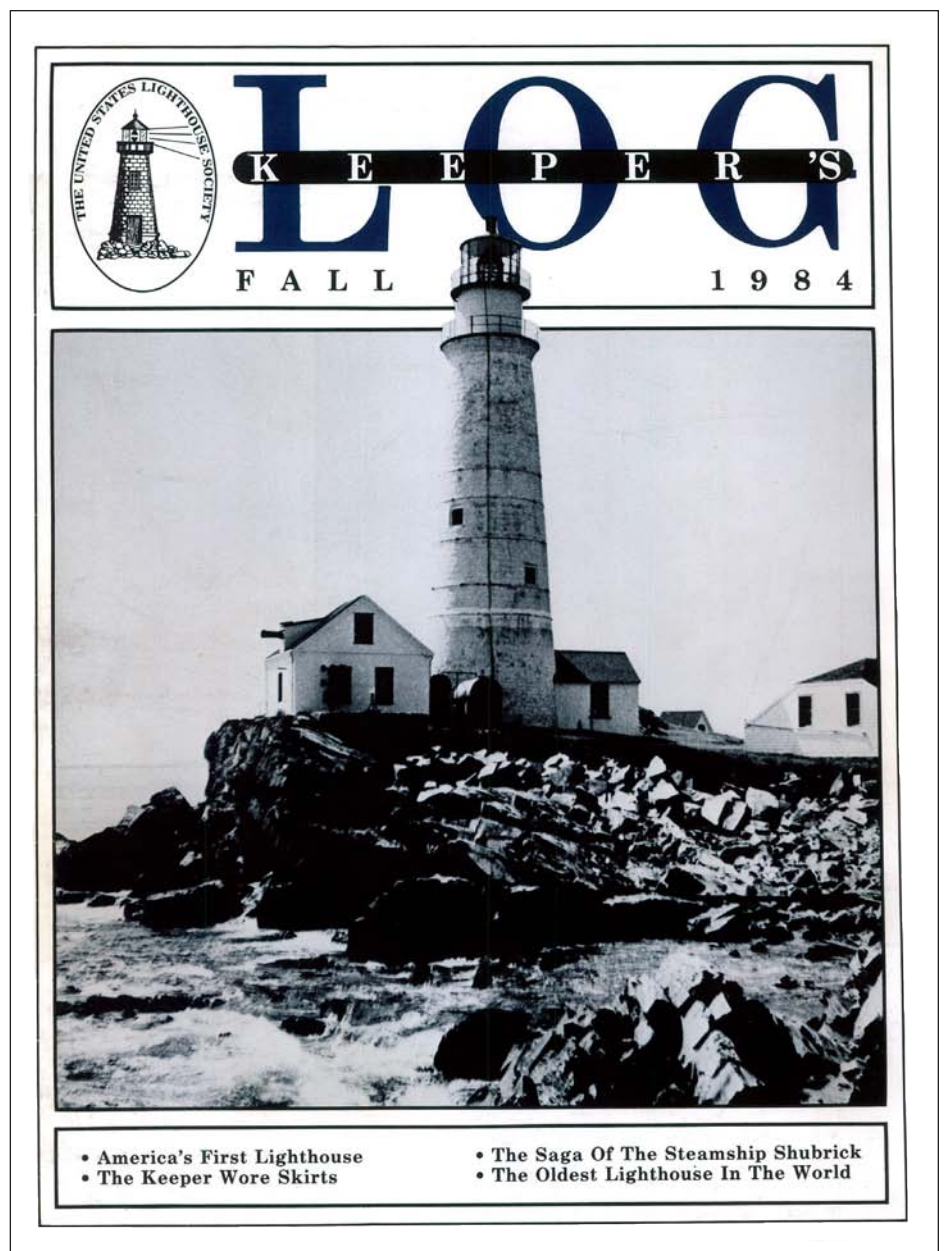

Cover of the very first *Keeper's Log*. USLHS archives.

10 had a national maritime funding category; applications went out and were rejected.

"So I put in \$1,000 of our own money," Wayne said.

By now Wayne was crossing the Bay Bridge to his Alameda office nights and weekends just to use the typewriter, juggling a full-time job and a busy speaking schedule with a ton of organizational work—and missing a San Francisco 49ers run to the Super Bowl. And he was working the media. There were repeat appearances on a radio call-in show in San Francisco, for example. "I'd do lighthouses, and the next time I'd do fog signals, and the

next time I'd do lightships," he remembers. Among the listeners to his talks and responses to questions were two men who came to see him: a representative from the Jostens year-book publishing company, who eventually got his company to agree to print magazines and wait three months for payment, and a Hollywood television producer, who came up with a camera crew to do four different public service announcements at no cost. They provided Wayne with 40 copies, and he sent them out across the country.

The timing was right. Historic preservation had gained an emotional foothold with

Americans who had more leisure time and more money to spare on new interests, and lighthouse preservation itself was gaining momentum. The Great Lakes Lighthouse Keepers Association also was starting up. Up in Maine, Wayne's good friend Ken Black was collecting and displaying artifacts. "At the same time Bill Davis in Rochester was chipping away at the Charlotte-Genesee Lighthouse all by himself . . . and the same time Sue Olsen was working to restore, with Cullen Chambers, the Key West Lighthouse and keepers' quarters, that was '89 [the keepers' quarters], and Charlotte Johnson had taken on Rose Island. There were people all over the country. It seemed there was a whole spate of things happening in the early 80s," Wayne said.

"We had TV coverage, I had coverage from newspapers, I had coverage from yacht clubs and historical societies."

The hope was for 1,000 members at the end of the first year, with expenses of about \$15,000 for the magazine, membership cards, and bumper stickers. Memberships were \$15, and life memberships were \$100—until so many people signed up for that that Wayne saw the light and increased them to \$500.

"We had no overhead, we had no salaries," he said. "By the end of the first year, we had 1,350 members, but our expenses were \$42,000—a little bit off! But we made enough money."

The arrival of the first issues of the *Keeper's Log*, a run of 2,000 copies, solidified everything. Wayne did get them mailed out, after a hassle over bulk-mailing rates, and after the second issue he sent two magazines to the Skaggs Foundation, which was impressed enough to encourage an application for a grant that funded a computer, typewriter, printer, two filing cabinets, and a copier.

"The dining room was stuffed," Sally Wheeler recalls. "You couldn't see the dining room table—and Wayne says, 'let's do Thanksgiving dinner.'"

Wayne had asked for \$9,400, but the Skaggs family foundation sent \$10,000, and thus began a relationship that eventually included not only more vital early grants but the friendship and advice of foundation manager Philip Jelley.

As the Society grew, so did the workload. At the end of the second year he was



Wayne (right) with Ken Black in the Shore Village Museum. USLHS archive photo.

offered a lightship, and he told the friends who made up his board of directors that the Society had to save it to keep it from being scrapped. That added even more work to the volunteer job.

"I don't like to delegate," Wayne said. "I wanted to do it all, so I did it all myself, although Sally did a lot. While I was working for the Coast Guard, and I did this for three years while I was working for the Coast Guard, during the day she's going to the printer, she's picking up paper and supplies, all that stuff. And also I had the board come over once a quarter and we stuffed the mailbag."

"We were in a lot of newspapers. It was magic, people calling all the time. Everyone was interested in this thing going on. People started sending stuff, they found stuff in their attics: pictures, books. They didn't know what to do with them, so they sent them to us. Packages were arriving every day in St. Elmo. It was like Christmas."

And then there were the fog horns.

While he was still in the Coast Guard, the agency had announced that it was doing away with air horns in the Bay, and that made the television news. Wayne did a lot of interviews, and perfected his once-famous "Beeeeeeee-OHHHHH" two-tone fog horn imitation. At the Society, he started getting letters from lawyers, residents, and communities that wanted to keep the

horns, and even emceed fog horn contests at the San Francisco Fair; from 3,000 to 4,000 people attended to hear the imitations and see the costumes. One guy came dressed as an ATM spewing dry ice vapor (a fog bank), another somersaulted across the stage covered in cotton (the fog rolling in), and a kid came dressed as an Indian ("a patchy" fog).

It was fun, but in time Wayne also faced a crucial decision. The Coast Guard was shifting his job to southern California, and the Society was based in San Francisco. He was only about nine months short of eligibility for early retirement.

At lunch one day after a tour of the lightship, Jelley asked him what he planned to do. Wayne said he was going to quit his job, sell the car, and hope Sally could get a job. The couple already was into a second mortgage to fix dry rot in their house, but it looked like they just might be able to get by. Jelley said, "After lunch I'm going to back to the board and recommend that we give you \$25,000 a year, as a stipend, for four years."

"And I dropped my fork," Wayne said. "I was just . . ." He still gets choked up about that, nearly 30 years later.

After two more years, the dining room finally cleared out. There was a growing need for an office, and the piles of stuff were moved from the St. Elmo house to a storefront on nearby Chenery Street. Office manager Tanja Rabbitt became the Society's

first paid employee. A couple of years later there would be another move to a former lawyer's office on downtown Kearny Street, which Wayne stocked with bookcases and some used office furniture from a realtor going out of business. Headquarters would remain there until just a few years ago. Jelley stopped by the new office, said he was impressed, and upped the stipend to \$35,000. By the end of that time there were four employees in the office, and the Society was good financially. The foundation asked Wayne to think about what he wanted, but Wayne was no longer worried about survival: "We were really humming along there."

Tours followed, based on member requests, and expanded from the Bay Area to the rest of the country and, eventually, overseas, with Wayne and the Society doing everything from planning itineraries to designing patches. "The tours were successful and bringing in money. I tried to keep the cost way down. At first I was just charging \$25 over the cost of the tour, and I had several people say 'Wayne, you're not charging enough.' These were the people on the tour, telling me I'm not charging enough! So eventually it got to be \$100 a person, and we were making pretty good money. Sometimes when we made more than I thought, I would send a check and some money back to the people, and that helped legitimize the tours."

Early volunteer and eventual board secretary Butch Skaar joined the very first year

and then helped with later tours, going out on his own to preview the routes and time everything out before paying for and taking the tours himself to help guide the drivers. The information proved invaluable to both Wayne and tour participants.

The lightship, in the hands of volunteers led by John Byrne, also was coming along and turning into a mini-museum, but the initial six-month berthling donated by Oakland on Jack London Square would stretch into 19 years. The perpetual need for equipment and repairs became a financial drain despite grants from Chevron and others. "It was always eating money," Wayne ruefully recalls, and that would last until another Bay Area nonprofit organization requested the ship for training two years ago. Byrne, *LV 605's* mainstay, would stay with the ship after the transfer.

And there was a surprise in store. The U.S. Postal Service issued a series of stamps featuring lighthouses, and the booklet included the Society's address (with the wrong ZIP



Wayne and Sally at the Thomas Point Shoal transfer ceremony in 2004. USLHS archive photo.



RELIEF LV605. USLHS archive photo.

code, of all things, which the Postal Service later complained to Wayne about). Wayne returned from a tour to Ireland to find boxes of letters requesting pamphlets. They kept arriving in overwhelming numbers. Finally one request included the stamp booklet, and the staff finally figured out what was going on. Wayne enlisted his mother to help stuff envelopes and send out brochures. "We got up to 7,000 or 8,000 members there," Wayne said.

"I couldn't wait to go to work in the morning, I never looked back on the Coast Guard. It's been the most fun thing I've ever done in my life, except for Sally and my son Scott."

"Every day the mail was exciting, people coming in whether it was for research—which I loved doing—or signing up for tours. This was all magic, this whole thing, this all came together."

THIRTY BEACONS OF LIGHT



Celebrating lighthouse history and lighthouse preservation provides a good time to reflect on progress made during the past 30 years, the lifespan to date of the United States Lighthouse Society. And that, in turn, offers the chance to look beyond your Society and to the network of organizations, agencies, policies, and individuals responsible for the gains that have been made and the heritage that has been preserved.

To recognize that wide and vibrant lighthouse community, the Society's board of directors has chosen to mark this 30th anniversary by naming 30 "beacons of light" that have helped guide lighthouse preservation through the years. The list amounts to a survey of lighthouse preservation and is the first effort in that movement to document its own history, but by no means is it comprehensive; we look forward to celebrating 50 beacons in another 20 years!

Our honorees also do not include any individual citations for members of the Society's board or staff who well may make others' lists of lighthouse community leaders—30-year Society president Wayne Wheeler, for instance, is a prime example. Beyond that, our criterion was simple: choosing who or what made an impact on America's lighthouse legacy and helped pass that legacy along to future generations. There was a far larger list of nominees from Society directors; chosen by vote and discussion, here are our key points of light.

THE NATIONAL HISTORIC LIGHTHOUSE PRESERVATION ACT

Passed and signed in 2000 after input from the lighthouse community, including the Society, and after American Lighthouse Coordinating Committee meetings with the General Services Administration regarding implementation procedures, the National Historic Lighthouse Preservation Act (NHLPA) is an amendment to the National Historic Preservation Act of 1966; it bypasses the standard and often detrimental federal government surplus property process that had been used for excess lighthouses in favor of a new system designed to find the best possible stewards for lighthouse properties.

Detailed applications are reviewed by the National Park Service to ensure financial viability and a commitment to the act's historic preservation mandates.

Sponsored in the Senate by Sens. Frank H. Murkowski of Alaska and Carl Levin of Michigan, and in the House by Rep. Mark Souder of Indiana with 12 co-sponsors, the bill established a national effort that so far is working very well to help groups to preserve lighthouses—stewardship transfers were completed successfully for two-thirds of the 100 lighthouses listed through 2013.

The Coast Guard has played a key role in the process, although the law also covers lighthouses managed by the Fish and Wildlife Service and Bureau of Land Management.

The NHLPA shows welcome federal support for lighthouse preservation, although a pilot funding program called the National Lighthouse Stewardship Act, introduced nine years later by Sen. Levin and Michigan Rep. Debbie Stabenow, has not become law.

KEN BLACK



Courtesy of the Maine Lighthouse Museum.

The late Ken Black began his long involvement with lighthouses during a 30-year career as a station and ship commander in the United States Coast Guard.

After first assembling displays for his station and then for the Coast Guard's First District headquarters in New England, Black went on to found and direct the Shore Village Museum in Rockland, Maine. At a time when the Coast Guard was scrapping equipment in favor of automation, the former Coast Guard warrant officer

saved some 570 important artifacts, many of them critical to the understanding of lighthouse history.

The recipient of several awards and honors for his lighthouse work, including the lifetime Ross Holland Award, Black was an important champion of the Maine Lights Program and other initiatives, and he helped organize the first national lighthouse preservation conference in Rockland in 1985.

THE UNITED STATES LIGHTHOUSE SOCIETY

No list of this sort would be complete without your Society, which has played a seminal role in promoting lighthouse history and awareness.

Its history is detailed elsewhere in this issue; among other things, the organization founded by long-time "Head Keep" Wayne Wheeler 30 years ago publishes the premier journal of lighthouse lore, history, and technology, and it has restored a lightship and two lighthouses. The Society pioneered lighthouse tours nationally and internationally, maintains a go-to website of lighthouse information, and is building a lighthouse preservation fund for future grant-making.

The Society got a major boost in the 1990s when the U.S. Postal Service linked it to its first in a series of stamp issues depicting lighthouses, and in 2009 First Lady Laura Bush presented the Society and its Chesapeake Chapter the Preserve America Steward Award during its 25th anniversary year.



Through the decades, board members have included Wheeler, Henry Gonzalez, Tom Tag, Ralph Eshelman, Mike Vogel, Ken Smith, RADM Bill Merlin, Brian Deans, Tim Blackwood, Butch Skaar, Sally Wheeler, Walter Fanning, Peter White, Ted Miles, Don Rutherford, Lee Collins, Dick Wilson, Roger Lehman, Jeff Long, Dan Swederborg, Donald Hoyt, John Byrne, Leeds Diston, Warren Wilson, Jon Cash, Charles Christensen, Lois Johnson, Robert Kenney, Joseph Blackett, Nelson Morosini, and Dolores Thacher. Jeff Gales is its executive director.

KEY KEEPERS

Preserving America's lighthouses is a long and ongoing effort more deeply rooted in local organizations and leaders than in the national organizations that shape the overall movement and give it a national voice.

Local historical societies and other community groups of dedicated and deeply involved persons have been the backbone of lighthouse preservation in this country.

And there have been individuals who have contributed so deeply by founding groups or taking projects to another level that their names still resonate in the larger lighthouse community—people like Bill Davis leading the very early Charlotte-Genesee Lighthouse preservation project in Rochester, New York; the late Ann Caneer at Ponce Inlet, Florida; Charlotte Johnson at Rose Island off Newport, Rhode Island; Kathy Fleming, who organized nationwide lighthouse stewardship programs while running the lighthouse organization at St. Augustine, Florida; Tom Butt and the first lighthouse not-for-profit association with a long-term lease at East Brother Island in San Francisco Bay; and Sue Olsen at Key West Lighthouse, Florida.

THE UNITED STATES COAST GUARD



Almost all American lighthouses belonged to the Coast Guard when historic preservation became a national concern, and every listing of “key players” in lighthouse preservation history must include the agency that found ways to preserve lighthouses even as changing missions, evolving navigational technology, and

shrinking budgets put the towers at risk.

Although there were inevitable confrontational and adversarial relationships, especially in the early years, the Coast Guard sought ways to work with not-for-profit and community organizations and to preserve not only the cultural and architectural treasures lighthouses represent, but its own heritage inherited from the U.S. Lighthouse Service.

Several Coast Guard officers played important roles in the lighthouse preservation movement, with officials such as CMDR Joe Blackett starting Coast Guard licensing of stations and lightships to organizations for creative reuse, and Bob Scheina, Bob Browning, and Arlyn Danielson, among other headquarters officials, providing valuable assistance to lighthouse groups as well as interpreting the Coast Guard's lighthouse-related history through both the Office of the Coast Guard Historian and the agency's curatorial services program.

The Coast Guard also has been an important part of such programs as the National Historic Lighthouse Preservation Act.

THE NATIONAL PARK SERVICE

Through its Maritime Heritage Initiative, the National Park Service (NPS) has provided a range of services ranging from a National Register Context Study for lighthouses to specific assistance to lighthouse groups.

The agency reviews and evaluates applications and performance for lighthouse stewardship deed transfers under the National Historic Lighthouse Preservation Act, and with the Coast Guard it developed and published the valuable *Lighthouse Preservation Handbook*.

It also researched and published an inventory of historic light stations, and it also joined the Coast Guard for standing structure studies for West Coast Department of Defense lighthouses.

It has done numerous successful National Register of Historic Places and National Historic Landmark nominations, including the Cape Hatteras and Cape Canaveral lighthouses. The NPS Historic Preservation Center under Tom McGrath partnered with the Buffalo Lighthouse Association and American Lighthouse Council to conduct a key lighthouse lens conservation workshop in Buffalo in 2002.

Greg Byrne of the NPS Division of Conservation also contributed a chapter on lighthouse lens conservation to the Council of American Maritime Museums' 1995 maritime disaster preparedness plan.

GREAT LAKES LIGHTHOUSE KEEPERS ASSOCIATION



Founded by Donn Werling and a group of Michigan lighthouse enthusiasts a year before the United States Lighthouse Society, the Great Lakes Lighthouse Keepers Association (GLLKA) is both a regional and binational lighthouse organization that has made outstanding contributions to lighthouse preservation throughout the Great Lakes.

Using publications, tours, and its magazine, *The Beacon*, GLLKA has documented the lakes' lighthouse history and heritage while creating a widespread information and activity network with chapters on each of the five lakes. The group also received a 30-year lease for the abandoned 1873 St. Helena Island Lighthouse in the Straits of Mackinac in 1986 and later converted that into a complete legislative transfer of the deed by Congress in 1997, after a restoration known widely as “The Miracle in the Straits” was well under way.

Run from 1985 through 2012 by Dick Moehl, GLLKA now is led by noted historian and researcher Terry Pepper as executive director and Steve Sheridan as president.

TIM HARRISON

A Michigan native who adopted Maine as his home state—making lighthouses a natural lifelong calling—Tim Harrison has been a major figure in the publication and preservation of Lighthouse Service history and lore and of news within the lighthouse preservation community.

He was the founder or co-founder of *Lighthouse Digest* magazine, the former renowned Lighthouse Depot gift shop in Maine, and the





Courtesy of Tim Harrison.

American Lighthouse Foundation (ALF) and its adjunct Museum of Lighthouse History, later merged into the Maine Lighthouse Museum where he has served as a board member.

Mentored by lighthouse preservation leader Ken Black, Harrison also organized a national light-

house education conference and now co-chairs the Friends of Little River Lighthouse and headed the group's restoration of that lighthouse in Cutler, Maine.

He retired from the Depot in 2004, and in 2007 ended his 13-year presidency of the ALF, which had grown to encompass 24 regional lights, 11 of them in Maine. He continues to edit the *Lighthouse Digest* with the help of Kathleen Finnegan, and his years of contributions have earned him the Coast Guard's Meritorious Public Service Award and rare designation as an Honorary Chief Petty Officer.

LIGHTHOUSE VOLUNTEERS

Volunteerism is the heart of the lighthouse preservation movement, which is deeply rooted in small and large communities across the country where projects stem from local pride in "their" lighthouses. Without thousands of volunteers, and very often the spouses of volunteers who themselves become key persons in lighthouse groups, the movement would not have been able to save nearly as many lighthouses or preserve their heritage and local lore.

These are people like John Byrne, a 25-year volunteer and employee at Light Vessel 605 while that Oakland-ported lightship was under successive ownership groups; the Michigan Ann Arbor Boy Scouts and Girl Scouts who have contributed years of labor and several Eagle Scout projects to the preservation of an island light in the Straits of Mackinac; Dot Black, the widow of Ken Black, who not only was his chief aide but went on to lead the Maine Lighthouse Museum after him; Walter Fanning, active with the early nonprofit group that won the Coast Guard's first long-term lease to restore the station at East Brother Island in San Francisco Bay; educator MaryAnn Moore, Sandy Planisek, Michelle Tregembo Wilson, and others at GLLKA; Paul Conlin at the American Lighthouse Foundation; the late Herb Entwistle of the Virginia (later Chesapeake) Chapter of USLHS; Bob

Trapani Jr. of the Delaware River and Bay Lighthouse Foundation before joining the American Lighthouse Foundation; researchers Al and Helen Gademsky of Ohio and Phyllis Tag of Illinois; Jeremy D'Entremont of Friends of the Portsmouth Harbor Light and the American Lighthouse Foundation; Jeff Shook at the Michigan Lighthouse Conservancy and Michigan Lighthouse Alliance; and Paul St. Germain of the Thacher Island Association.

THE MAINE LIGHTS PROGRAM

A landmark pioneer project launched in Maine in 1994, after negotiations to save the fire-damaged Heron Neck Light Station had taken a dismaying four years, the Island Institute's Maine Lights Program was an outstanding success that provided the model on which the nationwide deed transfer program of the National Historic Lighthouse Preservation Act was based.

The program transferred title to 28 historic Maine lights, many of them on islands, to qualified local communities, nonprofit organizations, and state agencies. Using legislation introduced in Congress by Sens. George Mitchell and Olympia Snowe, and headed by Anne Webster-Wallace, who also had founded the Friends of Seguin Island, Maine Lights was the first statewide lighthouse preservation program, and its legislation and the processes it established set the stage for the wider efforts that followed.

THE NATIONAL LIGHTHOUSE MUSEUM STEERING COMMITTEE

Born of lunchtime conversations in Washington's Union Station, the steering committee was convened in 1997 when historians Ross Holland, Valerie Nelson, and Ralph Eshelman decided a group of lighthouse preservationists should meet to consider the desirability and feasibility of a national lighthouse museum. Drawn from national groups, small local lighthouse preservation efforts, researchers, and



John Byrne (far left) gives a tour of LV605 to participants of the USLHS 2008 Northern California tour. USLHS archive photo by Chad Kaiser.

historians, the large committee met in Alexandria, Virginia, and decided such a museum would be a worthwhile endeavor that would not compete with existing groups.

The steering committee then continued meeting, at its members' own expense, to refine the concept and, ultimately, sought site applications and winnowed them down to six promising locations—Mackinaw City, Michigan; New London, Connecticut; Point Judith, Rhode Island; Rockland, Maine; Staten Island, New York; and Hull, Massachusetts—for personal visits, again at members' own expense, by a site selection committee.

Ultimately, that committee made its recommendation to the board, which again reviewed all the applications and in 1998 selected Staten Island as an easily accessible location in a highly populated area central to hundreds of school-district field trips, as well as the highly historic site of the former Lighthouse Service General Depot that was badly in need of preservation and restoration.

Beyond establishing the museum concept, though, the steering committee marked the first major collaborative effort across the entire lighthouse preservation community, a milestone in itself. Members included Wayne Wheeler, Ken Black, Ralph Eshelman, Cullen Chambers, Henry Gonzalez, Tom Laverty, Charlotte Johnson, Valerie Nelson, Don Terras, Jerry Roberts, Anne Webster-Wallace, Mike Vogel, Dick Moehl, Alex Wade, Joe Esposito, Gayle Haines, Henry Stephenson, and John McPherson, with Ross Holland as a nonattending member and Candy Clifford as an active advisory board member.

THE AMERICAN LIGHTHOUSE COUNCIL



The aftermath of the National Lighthouse Museum Steering Committee gave birth to another national organization, the American Lighthouse Coordinating Committee (ALCC). Later renamed the American Lighthouse Council

(ALC), the organization was based on steering committee recognition that community collaboration should continue in ways that often could include national legislative initiatives that would be difficult for a museum or non-profit organization to do.

ALCC was headed briefly by Dick Moehl and then, for nine years, by Mike Vogel before its presidency passed to current leader Don Terras. Along the way, the council commissioned and published on its website several position papers on such community-interest topics as lens conservation (Cullen Chambers), public access and visitor policies (Don Terras), and disaster preparedness (Mike Vogel), as well as an annotated list of lighthouse-related children's books and national lens and lamp inventories.

Dick Moehl photo by Jan Feltner, courtesy of Terry Pepper and the Great Lakes Lighthouse Keepers Association.

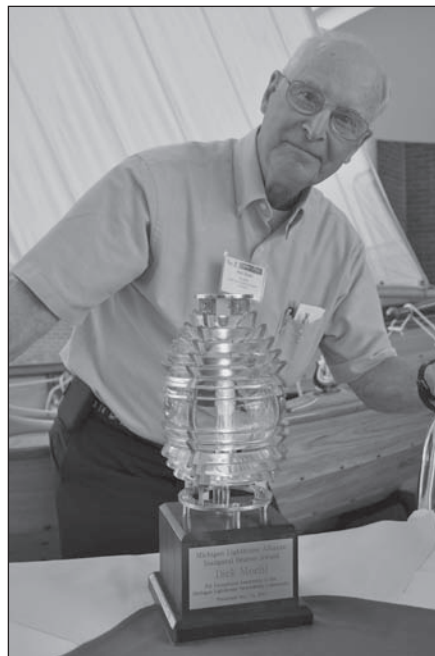

ALC, as it is now known, also organized and ran lighthouse topic tracks for four successive triennial Maritime Heritage Conferences, successfully built bridges of cooperation among lighthouse groups, worked with the General Services Administration to develop the implementation policies for the National Historic Lighthouse Preservation Act, and established the Ross Holland Award as the top national honor for lifetime contributions to lighthouse preservation and history.



THE NATIONAL LIGHTHOUSE MUSEUM



Originally titled the National Lighthouse Center and Museum, the National Lighthouse Museum (NLM) finally held its “soft” opening this summer after long delays tied at least in part to fund-raising delays caused by the impacts of the 9/11 terrorist attacks on the World Trade Center in Manhattan, just across New York Harbor from the Staten Island site of the former General Light-House Depot in Tompkinsville.

Located next to the landing of the iconic Staten Island Ferry, the site now hosts an educational resource center with plans to expand the museum into an adjoining 1907 lens shop, while three other historic depot buildings and six underground oil vaults could either see adaptive reuse or eventually become museum buildings as originally envisioned by the site group originally led by Henry Stephenson of New York Harbor Lights.

The original board included Brendan Sexton as president, Judith Hoffman and Ralph Eshelman as vice presidents, Wayne Wheeler as treasurer, Chan Graham as secretary, Henry Stephenson, Bill Baker, Chris Benbow, Ken Black, Cesar Claro, Jim Dunlap, Loren Graham, Gayle Haines, Tom Laverty, Valerie Nelson, Jerry Roberts, and Mike Vogel.

The site's history was detailed more fully in an earlier issue of *The Keeper's Log* this year.

Headed now by Linda Dianto, who successfully led a campaign to meet a New York Economic Development Corp. fund-raising challenge goal to enable the initial opening, the museum also has joined the American Lighthouse Council and *Lighthouse Digest* magazine in campaigning for federal designation of each Aug. 7, the anniversary of the founding of the federal lighthouse service in 1789, as National Lighthouse Day.

RICHARD L. MOEHL

Tireless in his enthusiasm for lighthouse preservation and unmatched in his ability to raise funds for his beloved Michigan lighthouses, Dick Moehl served as president of the Great Lakes Lighthouse Keepers Association (GLLKA) for nearly all of its first 30 years. He was the prime mover of the “Miracle in the Straits,” the saving of St. Helena Lighthouse on an island in the Straits of Mackinac.

An indefatigable lobbyist as well as a preservationist, he has testified many times before state and federal legislatures and played key roles in winning congressional approval of the Bicentennial Lighthouse Fund and passage of the National Historic Lighthouse Preservation Act. Widely honored by state and national governments and groups, including the lifetime Ross Holland Award, Moehl was the first president of the American Lighthouse Council.

He established and later moved the headquarters of GLLKA, championed Mackinaw City's bid to host the National Lighthouse Museum, and remains active in the St. Helena project.

THE MAINE LIGHTHOUSE MUSEUM

Formerly the Shore Village Museum, the lighthouse center in Rockland, Maine, was the creation of retired Coast Guard Warrant Officer Ken Black, himself a legend in lighthouse history circles. It has been the premier lighthouse museum in the nation for decades, with a wide-ranging collection of artifacts displayed on the Rockland waterfront. The museum moved in recent years from its crowded home in a house on Limerock Street to its current building on the harbor, and its exhibits have been expanded and reorganized, with information also provided by a dedicated group of volunteers.

CULLEN CHAMBERS

The late Cullen Chambers put his generous heart and gentle soul into lighthouse preservation, not only leading preservation efforts at three high-profile stations but giving unstintingly of his time and expertise to lighthouse groups across the country.



Facebook.com

He restored towers and keepers' quarters at Key West from 1987 through 1989, then at St. Augustine until 1994, and at Tybee Island until his death earlier this year. Those efforts alone involved more than \$3 million worth of work and were only part of an overall effort that also included major contributions in research, education, and program development.

A lifetime Ross Holland Award winner, Chambers was a key member of several national initiatives, developed a lens conservation policy for the American Lighthouse Coordinating Committee, and as a volunteer, wrote nearly a dozen historic condition assessment reports for lighthouse groups from Florida to Oregon.



Courtesy of Candace Clifford.

J. CANDACE CLIFFORD

Ask anyone deeply involved in lighthouse preservation to name the nation's top archives lighthouse researcher and you'll hear one name—Candy Clifford. Now an independent Washington-area researcher with unparalleled knowledge of National Archives lighthouse materials, she was a critically important consultant to the National Park Service Maritime Heritage Program from 1988 to 2001 and was primarily responsible for its databases, resource surveys and inventories, and produced the *Historic Lighthouse Preservation Handbook*.

A publisher and author of lighthouse history books, often with her mother, Mary Louise Clifford, she has documented the role of women in the lighthouse service, among other topics. Honored as well for other types of maritime history services, she is an officer and newsletter producer for the American Lighthouse Council and a recipient of the lifetime Ross Holland Award.

THE LAMPISTS

From a nationally recognized expert taught by old Lighthouse Service lampists to a Disney engineer experimenting with optical acrylic to develop replacement classic Fresnel lenses, a modern generation of lampists has contributed immensely to both lens conservation and historic displays.

Chief among them is James "Woody" Woodward, a former Coast Guard Great Lakes District expert who apprenticed under an old Lighthouse Service lampist and has now become one of a handful of conservationists with deep experience in lens work; he is often joined by former Coast Guard officer James Dunlap in using traditional techniques to restore lenses, while former Coast Guardsman Joe Cocking is often joined by Nicholus Johnston in restora-



Dan Spinella inside the Ponce Inlet lens house. Photo courtesy of Dan Spinella.

tions espousing modern conservation technology.

Also on the short list of experienced and qualified lampists are such practitioners as Kurt Fosberg and, formerly, Mike Van Hoey, while Dan Spinella of Artworks Florida has pioneered manufacture of working replacement acrylic lenses that open new possibilities in removing historic lenses to protective museum displays without leaving tower lanterns empty.

Lens conservation in general also has benefited greatly from national workshops, especially one hosted

in 2002 by the Buffalo Lighthouse Association with the American Lighthouse Coordinating Committee and the National Park Service, and by national inventory databases such as the Fresnel lens inventory developed by Mike Vogel from 1998 through 2001 with later updates continued by Tom Tag and Chad Kaiser, and a lamp database developed by Tag.

LIGHTHOUSE ENGINEERS

Few lighthouse projects have generated more publicity and public awareness of America's lighthouse heritage than the slow and careful moving of the 4,830-ton Cape Hatteras Lighthouse, America's tallest, some 2,900 feet away from its erosion-threatened location on North Carolina's Atlantic shore in 1999. The National Park Service project was completed by International Chimney Corp. (ICC) of Buffalo, with Joe Jakubik as the historic preservation project division head for Rick Lohr's company, and Expert House Movers of Maryland.

While other firms would enter the field, a development very important to lighthouse groups looking for specialized expertise in bricks-and-mortar restoration work, ICC would become a preeminent lighthouse engineering firm, moving six lighthouses so far and doing restoration work on several others.

Through the years, before and after the 208-foot brick tower was moved at Hatteras, lighthouses have been relocated, moved, or reassembled at such places as Block Island, Sankaty Head, Cape Cod, Baltimore, the Calvert Maritime Museum, and the Chesapeake Bay Maritime Museum in St. Michaels, Maryland.

Quality lighthouse preservation would not be as possible without the expertise developed by these engineering firms, often at the local but sometimes at the national level.

AUTHORS AND ARTWORK

To be preserved, lighthouse heritage and lore must be recorded. Generations of lighthouse enthusiasts and supporters have been inspired by historians, writers, photographers, and artists who have promoted both the stories and the scenic beauty of lighthouses.

The Keeper's Log—Fall 2014

In the fledgling years of lighthouse preservation, F. Ross Holland Jr., sometimes called the dean of lighthouse historians, was a 30-year National Park Service employee who later directed preservation for the Statue of Liberty-Ellis Island Foundation and was an early advocate for lighthouse preservation and for the Staten Island depot site; after his retirement, he wrote *America's Lighthouses: An Illustrated History*, *Great American Lighthouses* and other survey-type books that inspired preservationists and historians alike.

Even before Holland, Edward Rowe Snow had popularized lighthouses and other New England maritime history topics, and there have been other seminal lighthouse authors such as Elinor DeWire in the field of education and children's books, researcher Willard Flint on lightships, former keeper James A. Gibbs on West Coast lighthouses, the photographer-writer team of Bruce and Cheryl Shelton-Roberts, Candy and Mary Louise Clifford on female keepers and other history topics, Wes Oleszewski and Wayne Sapulski on the Great Lakes, and others.

PERIODICALS AND ELECTRONIC MEDIA

The preservation movement has benefited greatly from magazines and websites that not only publish researched and personal-recollection stories but serve to unite the community and tie its efforts together.

Such organization-based lighthouse publications as *The Keeper's Log*, *Lighthouse Digest*, *The Beacon*, and regional and local organization newsletters play an important role, as do Web logging and chat groups such as those organized by Kraig Anderson at lighthousefriends.com and Ross Tracy at lighthouseing.net, not to mention Candy Clifford's Lighthouse History blog and an array of Web sites, including the Society's uslhs.com, Terry Pepper's valuable and comprehensive "Seeing the Light" pages at terrypepper.com, Ross Rowlett's Lighthouse Directory website at the University of North Carolina, and many others.

Television productions, notably the PBS "Legendary Lighthouses" series, also have raised the profile of lighthouses nationwide.

Artists such as Leo Kuschel, whose detailed and accurate pen-and-ink works graced GLLKA magazine covers and calendars for years, and the late Bev Schreiber added their talents to the cause.

OUTER BANKS LIGHTHOUSE SOCIETY



An exceptional organization founded to support all North Carolina lighthouses and educate the public and students about lighthouse heritage, the Outer Banks Lighthouse Society (OBLHS) was founded by Bruce Roberts and Cheryl-Shelton Roberts, who also have produced exceptionally beautiful photography books on lighthouses.

OBLHS was the prime mover behind support for the move of Cape Hatteras Lighthouse, played an important role in the successful struggle of Currituck Beach Conservationists to gain stewardship of the Currituck Beach Lighthouse, and weighed in on debates over the disposition of the Bodie Island lens.

The group also staged landmark reunions of keeper families that

drew more than 1,100 descendants to Hatteras in 2001 and 300 descendants to Bodie Island in 2012, with both events producing valuable oral histories published in book form by Shelton-Roberts and Sandra MacLean Clunies.

The society also produces an excellent history-based newsletter.

PONCE DE LEON INLET LIGHTHOUSE & MUSEUM

The 170-foot tower at Ponce de Leon Inlet, south of Orlando, anchors one of the best preserved light stations left in America. Acquired by the town of Ponce Inlet in 1972 and run since then by the Ponce de Leon Inlet Lighthouse Preservation Association, the National Historic Landmark complex includes three keeper's quarters and support buildings including an oil storage building, pump house, generator building, woodshed, and privy.

Benefiting over time from such leaders as organizer, volunteer,

and director Virginia Ann Caneer and former curator Jim Dunlap, the station also has set a standard for lens conservation work and built a separate structure to display and interpret an array of Fresnel lenses, the best exhibit of its kind.

The association publishes a quality quarterly newsletter, as well.

LIGHTHOUSE BICENTENNIAL FUND

Precedent was set when Congress designated \$3 million from the federal Historic Preservation Fund as a special Lighthouse Bicentennial Fund to mark the 200th year of the federal lighthouse service. The designation was largely the work of the Lighthouse Preservation Society (LPS), an organization that played an important role in lobbying Congress and organizing national conferences for a few years in the early years of the movement before losing its influence in the national lighthouse preservation community.

The society, with major work by Valerie Nelson, created bicentennial



Ponce de Leon Inlet Light Station. Inside the white picket fence is the restored light station. Outside the fence are all the buildings added to complete and enhance the museum's mission. They are, from upper left, the Administrative and Maintenance Building. Left center is the two-story Admissions Center and Gift Shop. To the lower left is the Education Classroom and Training Building. To the right of the classroom building is the Davis Lens Museum, which houses a variety of Fresnel lenses. Photo courtesy of the Ponce Inlet Lighthouse Preservation Association.



Driving the first piling for a dock at Thomas Point Shoal Lighthouse. Photo by Henry Gonzalez.

exhibits for display in the Senate and House Rotundas and helped win federal designation of Aug. 7, 1989, as National Lighthouse Day.

LPS board member Paul Cabot also provided the funding for the early national lighthouse museum initiative.

A Merchant Mariner Memorial Act subsequently targeted proceeds from “mothball fleet” ship scrapping to benefit maritime preservation, with little initial success because of the economics of environmental restrictions.

The Bicentennial Fund, which had provided matching grants to some 160 lighthouse projects through the National Park Service, subsequently was joined to wider maritime heritage funding in the National Maritime Heritage Act of 1994.

But the precedent of government grants and attention to lighthouse preservation continued with such programs as Maine Lights and the Michigan Lighthouse Assistance Program.

OFFSHORE GEMS

Lighthouse preservation is difficult enough, but when it involves a tower that is wave-swept or offshore, the work is exceedingly hard and expensive.

That has not deterred some hardy souls from saving lighthouses that are especially meaningful in interpreting how isolated and challenging lighthouse keeping could be. A prime example is “The Miracle on the Straits,” a still-ongoing restoration and revitalization project that has spanned some three decades and involved hun-

dreds of volunteers from Scouts to seniors in restoring the remote and once-decaying lighthouse on St. Helena Island in the Straits of Mackinac. The island now hosts an array of programs and maritime heritage workshops.

But it is not the only such project—among others, DeTour Reef Lighthouse in Lake Huron once was one of the National Trust’s 11 most endangered places but is now beautifully restored. Its Preservation Society was the recipient of a Preserve America Stewardship Award from First Lady Michelle Obama, and it is open for tours and overnight “keeper” stays.

Rose Island Lighthouse in Narragansett Bay also has been lovingly restored and hosts week-long “keeper” stays.

East Brother Light Station in San Francisco Bay, one of the earliest light station restoration efforts and the first lighthouse project to gain a long-term lease from the Coast Guard, is now a Victorian dinner, bed & breakfast and has been an inn for more than 30 years, with those revenues funding restoration and maintenance of the complex with its lighthouse and working foghorn.

Thomas Point Shoal is a beautifully restored cottage-style screw-pile lighthouse in the Chesapeake Bay transferred to the City of Annapolis, accurately returned to authentic condition by members of the Chesapeake Chapter of the U.S. Lighthouse Society under the direction of Henry Gonzalez, Anne Puppa, and Hobie Statzer and open now seasonally for public visits.

STATE ASSOCIATIONS

In addition to national groups such as your Society and super-regional groups such as GLLKA, the lighthouse preservation movement has been strengthened by state associations as well.

Since 1996 the Florida Lighthouse Association has set standards for such groups, which often gather individual lighthouse preservation societies into an umbrella group to maximize marketing and influence within a state. The association's Gene Oakes Memorial License Plate Project won state approval of a license plate lighthouse design that benefits preservation, a concept used in other coastal states as well. The group—organized by Ann Caneer, with presidents including Oakes, long-time leader and co-founder Tom Taylor, and now Ken Smith—does an excellent job of promoting organizational networking to preserve Florida's 30 surviving lights.

The New Jersey Lighthouse Society, originally a state chapter of the U.S. Lighthouse Society, has developed a model two-day "lighthouse challenge" event promoting visits and donations to several lighthouses.

The Michigan Lighthouse Alliance also networks, works with the state, and hosts an annual conference.

Outer Banks Lighthouse Society offers events, publications, programs, and lobbying power.

There are vibrant sub-state groups such as the Sable Point Lighthouse Keepers Association in Michigan, as well, and there have been regional groups such as NELL, New England Lighthouse Lovers, which started out as a collector's club for Bill Younger's highly popular Harbour Lights models and became a broader lighthouse group that is now a chapter of the American Lighthouse Foundation.

And last, but by no means of the least importance, we close our Anniversary list of 30 lighthouse preservation beacons by noting four individual lighthouse projects that are either important to the movement or representative of the scores of preservation efforts that have taken place or are taking place across the country. They have raised the bar for lighthouse preservation, but they and others like them, too many to honor here, stand for the many efforts by thousands of lighthouse volunteers who have kept the lights, and their heritage, shining for all these years.

BOSTON LIGHTHOUSE

The first light station established in what became the United States, the earliest Boston Lighthouse was erected on Little Brewster Island in 1716 and replaced in 1783 after the first tower was destroyed in the Revolutionary War. The second-oldest surviving lighthouse in America, after Sandy Hook, Boston Lighthouse is a National Historic Landmark and a shining example of a federal preservation effort.

It is also notable as the last manned lighthouse in the country;



Boston Harbor Lighthouse on Little Brewster Island. USLHS archive photo.

Sally Snowman, Ph.D., has interpreted the role of a female keeper in costume for several years, after the late Sen. Ted Kennedy prevailed on the Coast Guard to continue staffing the beacon with a resident civilian keeper, with assistance from the Coast Guard Auxiliary, after it was automated in 1998.

GROSSE POINT LIGHTHOUSE

Another National Historic Landmark, the Grosse Pointe Lighthouse on Lake Michigan just north of Chicago was built in 1873 and first lit in 1874, and it became the first lighthouse activated by a photoelectric device when it was automated and its keepers were reassigned in 1934.

Just a year later it also may have become the first major lighthouse preservation project in America, and it survives today as a shining example of local government involvement in the field. The lighthouse was transferred to the city of Evanston, Illinois, in 1935 as part of a new unit of local government, later named the Lighthouse Park District, with its own taxing authority.

Long headed by author, professor, and historian Donald J. Terras, the district also established a Lighthouse Preservation Fund and in 2013 launched an extensive restoration of the tall brick tower.

NEW CANAL LIGHTHOUSE

A small lighthouse that looms large in the modern history of New Orleans, New Canal Lighthouse was all but destroyed by Hurricanes Katrina and Rita in 2005 but stands today as a shining example of community resolve and commitment to local heritage. Less a restoration than a reconstruction with salvaged pieces, the small lighthouse with a big local impact was rebuilt by the Lake Pontchartrain Basin Foundation in a seven-year, \$1.5 million project that saw the reopening of the station as a lighthouse museum and education center.



Above: Grosse Pointe Lighthouse in 2008. Photo by Tom Tag.
 Below: The rebuilt New Canal Lighthouse. Photo courtesy of the Lake Pontchartrain Basin Foundation.



SPLIT ROCK LIGHTHOUSE

Almost as iconic as the Coast Guard's Portland Head Lighthouse in Maine, a staple of lighthouse calendars everywhere, Split Rock Lighthouse is a tower atop a soaring cliff on the spectacular north shore of Lake Superior, and it is a shining example of state-supervised restoration and operation of an historic light station. Part of Split Rock Lighthouse State Park since 1971 and run by the Minnesota State Historical Society since 1976, the station has been beautifully restored to its 1920s appearance under the direction of Lee Radzak, the resident site manager since 1982.

The Keeper's Log—Fall 2014

Big Sur, Montauk, Tybee Island, Currituck, Race Point, Buffalo, Rockland Breakwater, Seguin Island, the Statue of Liberty, Fire Island, Navesink Twin lights—the list goes on and on. The movement is blessed that so many high-quality restorations have occurred—and challenged by those remaining to be done.

Meanwhile, lighthouse artifacts now are being collected as never before, through venues ranging from eBay auctions to knowledgeable collectors and dealers such as Jim Claffin of Kenrick A. Claffin & Son and Steve Gronow of the Maritime Exchange Museum. And the movement celebrates itself, through events such as the education/fundraising Great Lakes Lighthouse Festival, the nation's largest, founded in 1994 and run by Huron Lights in Alpena, Michigan.

There is, as you may have noted, quite a bit of lighthouse preservation history embodied in this list. At the very outset of our discussions, though, Society board members noted that we could not possibly be all-inclusive; we would welcome your letters, for publication or otherwise, commenting on or adding to this list and its look at three decades of evolution in the lighthouse community. We have been proud to be part of that, along with all of our members and everyone else who harbors an appreciation of the contributions lighthouses have made to

the development and culture of America.

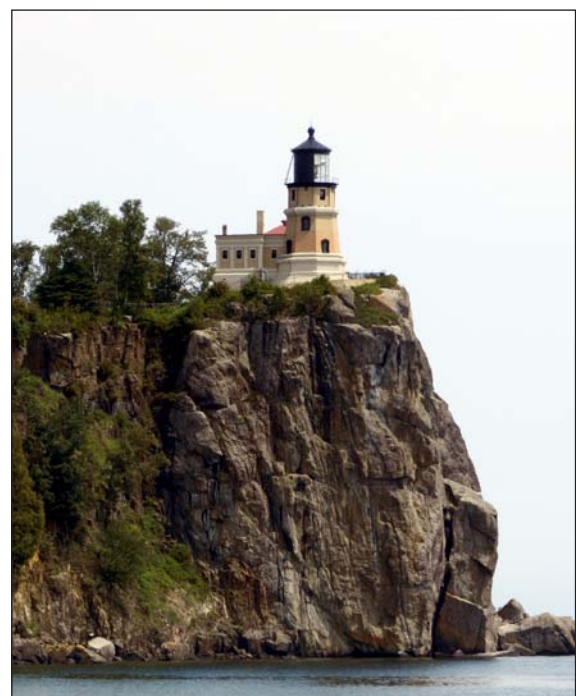

Split Rock Lighthouse, 2012. Photo by Marie Vincent.



The United States Lighthouse Society
thinks the following individuals
for their efforts on behalf of the Society in
2014



Keeper's Log

- Marie Vincent
- Dick Richardson
- Mary Borkowski
- Tom Tag
- Elinor DeWire
- Ellen Henry
- Ruth Drinkwater
- John Ibbotson
- Kent Weymouth
- John F. Mann
- Mary Louise Clifford
- J. Candace Clifford
- John Lopez
- Jeremy D'Entremont
- Joy & Pat Tubby
- Marc Pointud
- Rachel Weaver
- Beth Sylak
- Mike Vogel
- Neil Jones
- Keith Morton
- John Galluzzo
- Andy Rathbun

Outside Support

- Erik Nelson
- Anne Kessler

Office Staff and Volunteers

- Jeff Gales
- Melissa Eck
- Rich Gales
- Marie Vincent
- Skip & Mary Lee Sherwood
- Katherine Klint
- Rina Guevara
- Nancy Houghton
- Cassandra Rowland

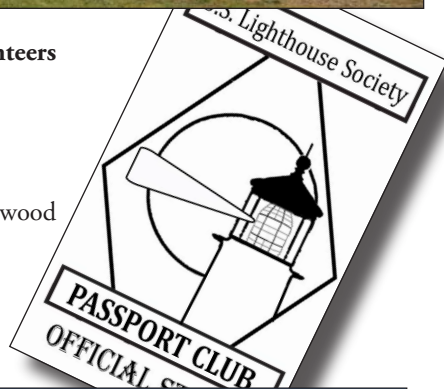

Special Projects

- John Byrne
- Chatt & Dawn Chapman
- Darlene & Tom Chisholm
- Gregg Gregory
- Lilla Mariotti
- Gary Riemenschneider
- Sonja Selboe
- Dolores Thacher

Museum Store

- Marie Vincent
- Shelley Douglas
- Peggy Dow
- Katie Ericson
- Kyle Charpie
- Erica Peach
- Sonja Selboe

Tour Coordinators

- Judy & Bill Newblom
- Brian & Cindy Deans
- Marge Czop
- Mike Boucher
- Skip & Mary Lee Sherwood
- Wayne & Sally Wheeler
- Megan Bradley
- Rich Gales

Passport Club

- Skip & Mary Lee Sherwood
- Melissa Eck
- Al King
- Mac Macfarland
- James Hill





By Wayne Wheeler

Reprinted from The Keeper's Log Vol. V No. II Winter 1989 and Vol. V No. III Spring 1989



he first colonial American aid to navigation, of which we have firm evidence, was the beacon erected at Nantasket (now Hull) Massachusetts in 1674. The beacon was a small stone tower erected at Point Allerton, a promontory guarding the south approach to Boston Harbor. The citizens of that community provided funds to furnish “fir-bales of pitch and ocum” in an iron basket surrounding the small beacon.

Our first lighthouse was erected of rubble stone on Little Brewster Island (in Boston Harbor) by the Province of Massachusetts Bay in 1716 at a cost of 2,285 pounds. The first keeper of that lighthouse was George Worthylake, who was paid the princely sum of 50 pounds a year. Other colonies also constructed lighthouses of rubble stone prior to the revolution. The collector of customs of the ports near the lighthouses collected “light-dues” based on the tonnage of vessels using the ports.

On August 7, 1789, the 9th Act of our first Congress, and the first public works act, provided for the transfer of the 12 existing lighthouses in this country from the individual states to the federal government and provided:

That all expenses which shall accrue from and after the 15th day of August 1789, in the necessary support,

maintenance and repairs of all lighthouses, beacons, buoys and public piers erected, placed, or sunk before the passing of this Act, at the entrance of, or within any bay, inlet, harbor, or port of the United States, for rendering the navigation thereof easy and safe, shall be defrayed out of the treasury of the United States; Provided nevertheless, that none of the said expenses shall continue to be so defrayed by the United States, after the expiration of one year of the day aforesaid, un-

less such lighthouses, beacons, buoys and public piers, shall in the mean time be ceded to and vested in the United State, by the state or states respectively in which the same may be, together with the jurisdiction of same.

The states, however, wary of a central government, dragged their heels, and it wasn't until 1797 (eight years after passage of the act) that all lighthouses were turned over to the fledgling government.

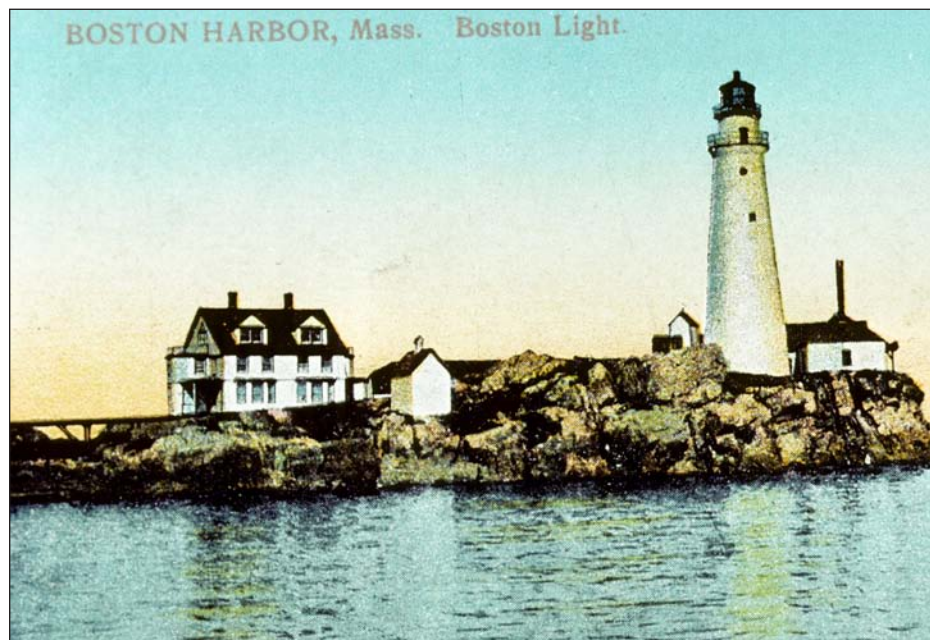

An old postcard of the Boston Harbor Lighthouse. USLHS archives.

The 12 existing lighthouses were soon joined by four which had been under construction when we became a nation: Cape Henry, Virginia, at the entrance to Chesapeake Bay (1791); Tybee, Georgia, at the entrance to the Savannah River (1791); Portland Head, Maine, (1791); and Bald Head at the entrance to the Cape Fear River, North Carolina, (1796). Cape Henry is regarded to be the first to be constructed by the new government. By 1800 there were 24 lighthouses in the nation, all along the Atlantic coast.

The responsibility for lighthouses and other aids to navigation was placed under the secretary of the treasury, at that time Alexander Hamilton. He had appealed to President Washington: in keeping with our free country, lighthouses should be as free as the air and that this country should waive the lighthouse dues which had been imposed by the colonies and were standard at most ports of the world. George Washington agreed.

Local control of our lighthouses was assigned to the collector of customs of a port. Some collectors had but one lighthouse to “manage,” while others had many under their control. And, because the collectors were politically appointed, the keepers were politically appointed. When the Whigs were

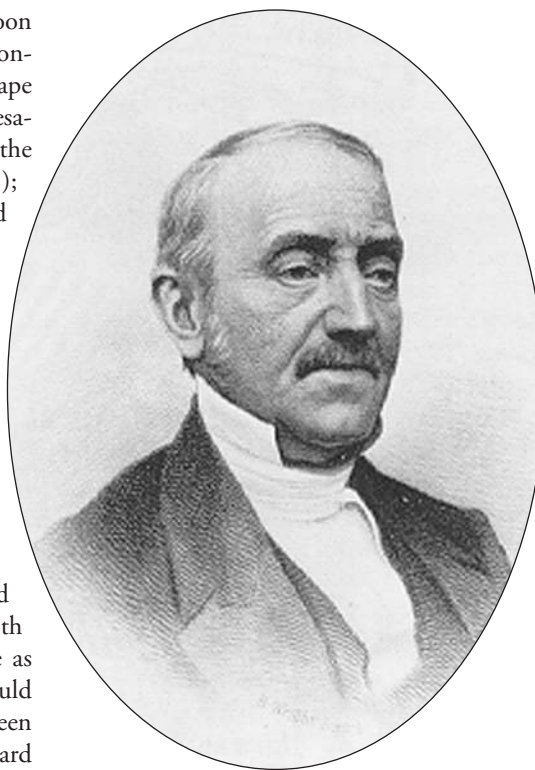

Winslow Lewis. USLHS archives.

in the White House, the Whig keepers were in the lighthouses.

It’s interesting to read about the involvement that our early leaders had with such trivial matters (for a chief executive) as appropriations for purchase of buoy chain and

appointment of lighthouse keepers; it was surely a slower pace than today. The keeper of the Seguin Lighthouse in Maine wrote to President Washington requesting an extra allowance for clearing the land adjacent to his station. He received a letter dated Jan. 24, 1797: “For the reasons assigned within, the allowance of \$150 is approved by G. Washington.” On another occasion he made the following endorsement on a contract to furnish mooring chain for a floating beacon in Delaware Bay: “April 17th, 1798. Approved, so far as it respects the new chain; but is there an entire loss of the old one? G. Washington.” Earlier in 1796 President Washington signed an executive act raising the annual rate of compensation for the 16 lighthouse keepers of the nation from \$120 to \$333.33.

Between the establishment of the Lighthouse Service in 1789 and the year 1820, the responsibility for our aids to navigation bounced around Washington like a Ping-Pong ball. On May 8, 1792, the department of the Commissioner of Revenue was created and the responsibility for aids to navigation was shifted to that agency. This department was abolished on April 6, 1802, and lighthouses were back under Treasury. Then in 1813 The Commissioner of Revenue was re-established and that agency was again responsible for lighthouses and aids to navigation.

Four years later, in December of 1817, the Commissioner of Revenue was abolished for the last time, but the act was not to take place until 1820. On July 1 of that year, the Lighthouse Service shifted again to Treasury and under the watchful eye of the fifth auditor, Stephen Pleasonton, an accountant, who knew nothing of lighthouses, lighthouse equipment, or engineering. Fifth Auditor Pleasonton held sway for the next 32 years; three decades during which other maritime nations of the world embraced the Fresnel lens (perfected in 1822) and other improvements in aids to navigation. This was a period in which our country lagged behind other maritime nations in aids to navigation.

During Pleasonton’s reign as general superintendent of lights (1820-1852), the aids to navigation of this country increased from a rather modest 55 lighthouses and a few buoys to 325 lighthouses and lightships and numerous other aids to navigation (buoys, daymarks, range lights, etc.)

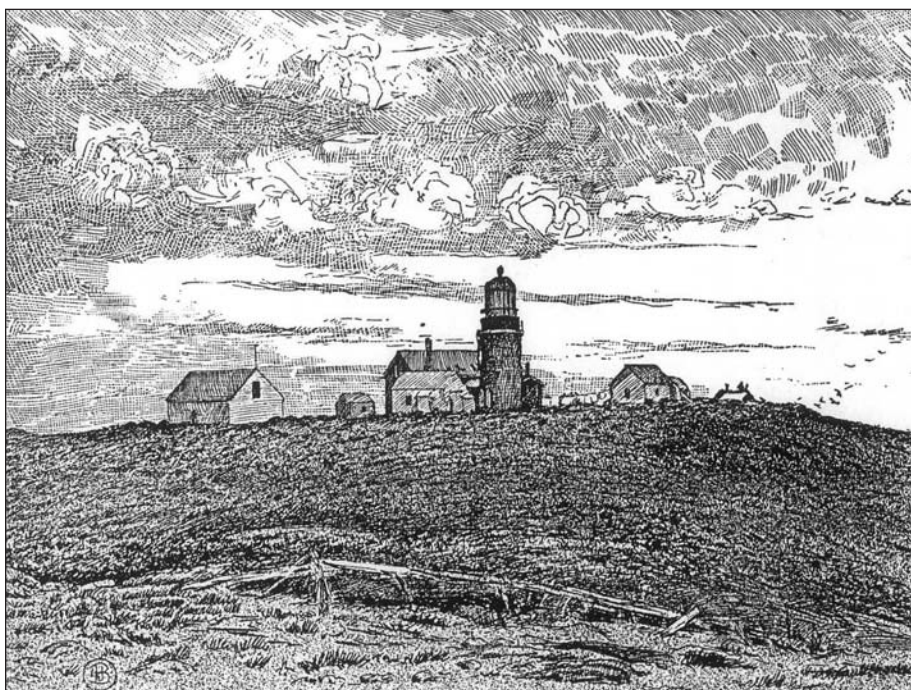

Seguin Lighthouse, Maine, from an old woodcut. USLHS archives.

The fifth auditor supplied the various lighthouses in his charge and even had them inspected by contract. Local contractors made yearly visits repairing the illuminating apparatus as necessary and furnishing oil, glass chimneys, and cleaning stores. This worked after a fashion when there were only 50 lighthouses, but as the number of stations increased, the time and paperwork necessary to manage individual contracts became impossible.

Thus, Pleasonton advertised for proposals for one contractor to furnish supplies for the entire Lighthouse Establishment and to keep all lighthouse apparatus in complete repair, bids to be submitted as cost per lamp per year; the winning bid was \$35.87 per lamp per year. In those days, before the introduction of the Fresnel lens in this country, some lighthouses had as many as 30 lamps and reflectors in the lantern room.

The optical system in use during Pleasonton's term was the catoptric system consisting of an Argand wick lamp(s) fitted with a parabolic reflector(s). Back in 1812 the government purchased a patent for a "reflecting and magnifying lantern" from Winslow Lewis of Boston for \$20,000. Lewis was an unemployed ship captain with no engineering background or knowledge of optics. He apparently "borrowed" the Swiss Argand's lamp and parabolic reflector design, although one critic of his optic stated that the reflectors were as close to a parabola as "a barber's basin." To make matters worse, Captain Lewis had round green lenses placed in front of the lamps which drastically cut the range of the light. After Lewis had outfitted all of America's lighthouses in 1815, the government started to remove the green "lenses," but it was many years before all of them were disposed of.

After Stephen Pleasonton took control, he continued to rely on Winslow Lewis for technical advice and even awarded him several contracts to construct lighthouses, several of which collapsed in very few years.

The Investigation of 1837-38

The 19th century was the Golden Age of lighthouse and maritime commerce. The number of lighthouses in this country went from 24 in 1800 to around 850 by the turn

of the 20th century. The first lightship station was authorized in 1822, and by 1900 there were 50 stations on every coast and in the Great lakes. Numerous types of fog signals were invented, our system of buoyage codified, the *Light List* developed, and *Notice to Mariners* published in a consistent manner. While some lighthouses were constructed in the 20th century, new fog signals developed, and electronic aids to navigation (radio beacons, etc.) introduced, it was the 19th century that saw the greatest growth of aids to navigation in this country and throughout the world.

As trade between America and Europe increased, and more and more Fresnel lenses were established in the lighthouses of Europe, our sea captains complained that our lighthouses were vastly inferior. In the 1830s and 40s two critics of our system, and Stephen Pleasonton, were E. & W. Blunt, publishers of Blunt's *Coast Pilot* (a publication of sailing directions used to this day). They wrote to Congress that "the lighthouse

establishment was badly managed." In a letter to the secretary of the treasury (November 30, 1837), they stated that the annual sums appropriated by Congress "were not judiciously or energetically used." They continued that "the establishment has increased beyond the ability of any single individual at Washington to superintend in its more important details." They also included editorials in the preface of the *Coast Pilot* blasting our aids to navigation. Another critic of our system of aids to navigation was I.W.P. Lewis, nephew of Winslow Lewis.

In 1837 Congress made an appropriation for the construction of a large number of lighthouses and other aids to navigation. However, the act stated that before any of the funds could be expended, the Board of Navy Commissioners should make an examination to determine whether safety of navigation required any additional facilities and, if so, what was the most suitable for each place. The Navy department detailed 22 officers, who reported to Congress. As a result of this "investigation," the construction of 31 planned lighthouses was deferred. The board reported that the arrangements in force for the managing of our aids to navigation were the most economical that could be devised but that they were "sufficiently effectual." It recommended the creation of an office to be known as "The Auditor of the Department of State and General Superintendent of the Lighthouse Establishment" [Keep'- how's that for a handle?]. This office was to take the responsibility from the fifth auditor, but it never happened.

In 1838 the Senate passed a resolution to import one or two Fresnel lenses for comparison and to investigate if our system of managing lighthouses should not be changed. The Congress also authorized the president to divide the Atlantic Coast into six districts and the "Lake Coast" (Great Lakes) into two districts and to assign a naval officer to each district. Under this act, in August 1838, the districts were created and a naval officer was detailed to superintend each district. A revenue cutter, or hired vessel, was assigned to each officer so that he might inspect each lighthouse in his respective district.

As directed by congressional fiat, a first-order fixed and second-order revolving Fresnel lens were imported from France and

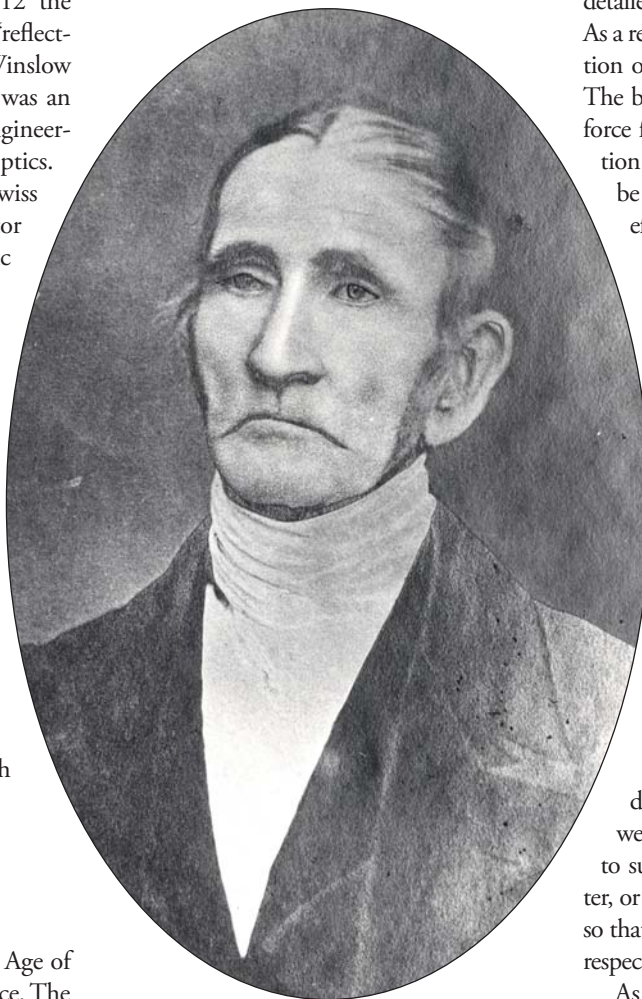

Stephen Pleasonton. National Archives image.

installed in the twin towers of the Navesink Lighthouse at the Highlands of New Jersey. Although even Fifth Auditor Pleasonton was impressed with the increased quality of light from the Fresnel lens, he declined to purchase them, stating that they were too expensive. The fact of the matter was, that while the initial cost of a Fresnel lens was greater than a reflector system, in the long run it was considerably less expensive. First, a primary seacoast lighthouse might have 24 lamps with reflectors each burning oil, whereas a Fresnel lens relied on a single lamp, thus resulting in a considerable savings of oil, not to mention wick material, lamp replacements, and time. Second, the silver on the face of the copper parabolic reflectors eventually wore out from polishing, whereas the Fresnel lens was basically good forever. But finances aside, the lenticular Fresnel system was vastly superior to the reflector system and Pleasonton just couldn't see the value of importing them.

As instructed, the new district inspectors began their investigation as to the state of "their" light stations.

In 1837 Lieutenant George M. Bache conducted an "inspection" of aids to navigation in the 3rd District (Newport, Rhode Island, to New York City). His comprehensive report included testimony from sea captains, findings of the state of lighthouses, and recommendations for new aids to navigation as well as improvements to existing aids and the manner in which the system was being managed. Some of the more salient points raised by Lieutenant Bache were (1) "More accurate information respecting the utility of a light appears to be required before its establishment is authorized." That is, perhaps the government should talk with ships captains and others aware of a particular area, that the amount and type of commerce transiting the area should be studied before a site and design were selected. (2) The exact site should be selected jointly by a seaman and the engineer. (3) The appropriation should be based on a final design (suited to the locality) and selection of the type of optic. (4) Better construction of lighthouses and lightships should be provided for.

He also felt that those who had erected



First-order Fresnel lens from Sombrero Key, on display at the Key West Lighthouse Museum. USLHS archive photo.

lighthouses in the past lacked the knowledge of setting up the illuminating apparatus and making repairs to same, that oil should be inspected before being accepted, that good management was missing, and more inspections were needed. Lieutenant Bache even went so far as to suggest that the nation adopt a uniform system of buoyage.

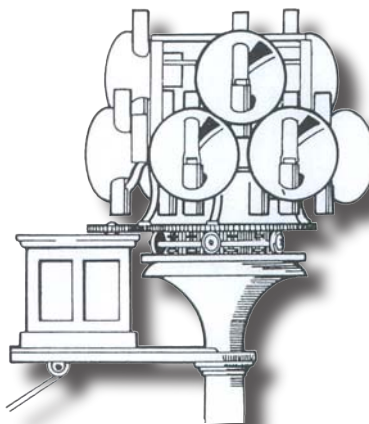

lighthouses in the past lacked the knowledge of setting up the illuminating apparatus and making repairs to same, that oil should be inspected before being accepted, that good management was missing, and more inspections were needed. Lieutenant Bache even went so far as to suggest that the nation adopt a uniform system of buoyage.

light station which was constructed in 1838. The fixed and rotating Fresnel lens (dioptric system) had been in use in Europe since 1822. But even the archaic catoptric system had, since the turn of the century, provision for rotating banks of reflectors and producing a flashing characteristic. Yet, at Nauset, Pleasonton had Winslow Lewis construct three towers in a row to provide a characteristic of three fixed lights. This was reportedly to ensure that this station wouldn't be confused with the twin towers (two lights) of Chatham. By not using the Fresnel lens, or even a rotating reflector system, the service would be required to maintain three towers (in lieu of one) and three banks of fixed reflectors, each with 10 lamps to keep fueled, 10 wicks to trim, and ten 13-inch reflectors to keep polished.

Left: Revolving catoptric light.

Shortly after the coast was divided into districts, the inspector for the 1st District, Lieutenant Edward Carpenter, USN inspected the lighthouses of his district and submitted a report in November of 1838. On the Nauset lights he reported:

Half-way between Cape Cod [Highland Lighthouse] and Chatham lights, on the Tableland of Nanset [Ed.: Old spelling of Nauset], have just been erected three stone towers, 15 feet high and 150 feet apart... This is a clean, bold, regular coast; no port to be guided into by these lights, making it difficult, at first, to comprehend their use. Never, before, seen any similarly located, I found it difficult to reconcile myself to them on any terms. They were doubtless, given this triple appearance to distinguish them from Chatham lights...Nanset beach has always been considered a dangerous place for vessels...to guard against such disasters seems to be the object of these lights. I cannot, however, think that three lights are at all necessary. Any single distinguishable light that can be seen eight or ten miles will answer every purpose. Such a light is a *revolving red light* [Ed.: Our emphasis].

Lieutenant Carpenter went on to justify why one rotating colored light would suffice and stated: "I cannot believe that the government will consent to consume 900 gallons of oil, when 300 or 360 will answer every purpose." He stated that he was going to recommend conversion to a single tower and light. At this point the station had not been placed into operation, but the newly assigned keeper was expecting oil for that purpose momentarily.

Another inspection as a result of this congressional inquiry revealed several lighthouses to be in deplorable shape. Lieutenant William D. Porter wrote:

Smith's Island—This tower built of bad materials; the cement has already been affected by the atmosphere, and is crooked in many places...Light badly kept. Keeper's dwelling requires to be new shingled, new plastering for dwelling and kitchen; glass for the house; new floors an hearths.

Bowler's rock light-boat—Found the captain, mate and crew absent...[the lantern] smokes badly...the boat requires calking and painting...

Smith's point light-boat—Captain absent, with all the crew for a week, the boat left in charge of a black boy, 14 years old; the lantern half-mast, and could not be hoisted by the boy...the boat requires new rigging; the lanterns are badly constructed, and the lamps lose oil.

Highlands of Navesink—The revolving light burns fifteen lamps, with parabolic reflectors; the works [ed.-clockworks] slightly out of repair; the window sills and many of the beams rotten; silver burnt off the reflectors...tower leaks in many places; the light shows badly toward the north.



Three Sisters of Nauset. USLHS archive photo.

On and on the report went, describing a lighthouse establishment out of control. There were some good reports, remarks of well kept stations and dedicated keepers...but for the main, a great deal was left to be desired.

Inspector Pleasonton managed to wiggle out of these reports to his superiors, but the sharks were gathering and new investigations were forthcoming.

The Investigation of 1842-43

In February 1842 the House of Representatives resolved, in part,

That the Committee on Commerce inquire into the expenditure of the lighthouse establishment since the year 1816, including expenditures for the building and repairing of lighthouses, light-ships...and make a report of the result of their inquiries, and also to examine into the propriety of reorganizing this establishment; of changing the mode of its superintendency... and of so modifying the laws and practices under them...as to secure strict observation of the duties of superintendents and keepers of lights.

It was further resolved that the committee should look into better regulations for the service and determine if the lighthouse service should be placed under the Topographical Bureau.

In May 1842 the committee submitted its exhaustive report which, overall, took a rather kindly view of the existing administration as indicated by the following excerpts:

"From July 1820, when the number of lighthouses was 55, to the present year, when the number of lighthouses is 256, of light boats 30, of beacons about 35, and of buoys nearly 1,000, the establishment has been under the charge of the present general superintendent,

the Fifth Auditor of the Treasury. It might well be expected that a twenty-two years' service would have given to the incumbent an experience and a practical knowledge of his business, which should not, for slight causes, be lost to the public." The report stated that maybe new expenditures should be made...that "When an old and well-tried system works tolerably well, change

and experiments should be avoided.” And while it is true that complaints have been made...why, they would be made no matter who was in charge. The committee saw no reason to change of transfer the existing system...they stated that the system, as it existed, could compare favorably with any nation in the world.

On the day that report was submitted to the House of Representatives, Secretary of Treasury Forward appointed I.W.P. Lewis (Winslow’s nephew), a respected engineer, to make an examination of our aids to navigation and the management of same. I.W.P. Lewis inspected 70 lighthouses in Maine, New Hampshire, and Massachusetts, which represented one third of the nation’s total.

The I.W.P. Lewis Report

After a general introduction, describing the unusual features of the Maine coast, etc., I.W.P. Lewis seriously questioned the decisions that had been made as to the placement of lighthouses and minor aids to navigation, use of characteristics, and even inaccuracies of charting the aids to navigation. He found that small backwater lights had more reflectors in the lantern rooms than major seacoast lighthouses:

None of the great coast lights have more than ten lamps, except those near Portland, which have but fifteen. The beacon-light on the Penobscot River has as many lamps, and much larger and better reflectors, than the great coast light of Petit Manan, where three wrecks have occurred since the period of this examination [Ed.: About four months]...As a rule of universal application to the lighthouses of this coast, resulting from careful observation in clear weather, it may be stated that the towers can be seen further by day than can the lights they respectively bear by night. In the structure of the lanterns and fitting up of the illuminating apparatus, all established rules and principles governing the subject are set at defiance.”

Concerning buoys and beacons he noted:

Many of the existing beacons are located in close harbors, where they are of but little use, while there are but four on the entire coast of Maine that occupy exterior positions; and the



Secretary of Treasury Walter Forward.

same remarks apply to the buoyage of these waters. There are buoys in abundance on Kennebec river and in the snug harbors...but on the immense number of outlying rocks and dangers there are none whatever; not one buoy, beacon, or spindle, to be seen in the whole navigation of Penobscot bay. More than 10,000 sail of merchantmen pass annually through the Muscle Ledge passage...and this channel being notoriously dangerous, the utmost care is observed, by those who enter it, to avoid the sunken rocks and ledges, notwithstanding which, every day, almost, vessels are seen hard and fast upon one or other of these dangers.

Lewis slashed sway, holding back nothing. “The mere arrangement of distinguishing lights on the coast of Maine will prove that there is neither knowledge of the wants of navigation, nor any attempt made to ascertain those wants.”

Lewis was appalled at the lack of variety in light characteristics assigned. He was amazed that certain areas of the coast had several lights in a row that were multiple or of the same flashing characteristic and that “From Monhegan island seven fixed lights are visible in one view.” It was very difficult, if not impossible, for a mariner to tell which light was which, or to fix his position. He noted that all the lights of Penobscot Bay were fixed and that there were only four rotating (flashing) lights on the coast of Maine and that they “are so badly fitted up that

they frequently stop in their rotations, and become fixed lights in effect, though visible only in two directions.”

In Massachusetts he found the greatest danger to lie with the “Cohasset rocks” (better known to us as Minots Ledge). Ships entering Boston Bay during a northeast storm are driven on the ledge which is “annually the scene of the most heart-rending disasters.” Although petitions had been circulating for years to erect a lighthouse on Minots Ledge, nothing was done about it and, in fact, the situation was acerbated by the presence of the Scituate Lighthouse “behind” the reef. I.W.P. Lewis stated:

One of the causes of frequent shipwrecks on these rocks has been the light-house at Scituate, four miles to leeward of the reef, which has been repeatedly mistaken for Boston light, and thus caused the death of many brave seamen and the loss of large amounts of property. Not a winter passes without one or more of these fearful accidents occurring. Notwithstanding this fact of the mistaken location of Scituate light (which is of no local importance whatever, standing at the entrance of an obscure harbor...) has been notoriously public for years, and nine out of ten of the wrecks on Cohasset rocks [Ed.: 416 wrecks in the general area in nine years] attributed to its evil influence; still no report...has ever been made to Congress by the superintendent.

Lewis continued his inspection, noting that off the beaten path lighthouses often had more lamps and reflectors than major seacoast or harbor lights, like Boston; that some areas had clusters of lights and other stretches were devoid of any light at all. He attached the rated range of the various lights. The Lighthouse Service stated in *Light Lists* that a light with an elevation of 70 feet should be seen for 19 miles, when in fact the curvature of the earth will only allow a light at this height to be seen for 11 miles, not that the crude lamp reflector system would have that range were it properly elevated.

The inspection then shifted to the construction of the lighthouses. He began by castigating the very mortar that they were constructed with, stating that the mixture of lime and sand was in such proportions that no “set” could be possible. He stated that there were two basic types of lighthouse



Scituate Lighthouse, circa 1857. Note the keeper in the lantern room and that the optic is off center. By this date a Fresnel lens has been installed. USLHS archive photo.

in his area of inspection: “conical towers of rubble stone masonry, and wooden-frame towers, erected upon the roofs of the keepers’ dwelling-houses...a description of one of each kind will apply to all.”

He noted that the rubble towers were capped by large slabs of soapstone laid on the top of the tower (projecting over from six to twelve inches) and not in any way fastened to it. Thus during storms water was driven up the tower and between the soapstone slabs and tower wall and that “large quantities of water remain [in the tower] after every rain storm.” Then the water seeps down through the tower destroying the weak mortar, leaving sand and rotting the wood frame of the structure. Of course in winter this effect is worsened with the advent of ice, or the freeze-thaw situation. He found of the 31 lighthouses upon the coast of Maine, 24 were “injured from this cause alone.”

Of the wooden, tower-on-the-roof type of structure he stated:

The angle posts [of the lantern] rest upon the attic floor beams, and are not supported by studding of any kind from

below; consequently the whole weight and stress of the tower and lantern are borne by the horizontal beams...In every example of this method of construction...the same results were apparent, viz: a distortion of the framing of the roof of the house by lateral swaying motion of the tower in storms, and constant opening of all the joints, causing profuse leakage. The same movement of the tower destroys the plastering of the ceilings beneath, and the frame work of the house rapidly decay.

He was shocked by not only the method of construction and workmanship, but by the design of the quarters:

...a division of the principal floor into three rooms, having a cellar beneath, and three above in the attic, which are always small and inconvenient, besides being cold and uncomfortable. The details of the work and materials are of the very roughest description, requiring regular annual repairs...At every station the complaint of smoky chimneys was made...very few of the stations were provided with the proper means of obtaining pure water.

He found that many remote and isolated stations either had no boat assigned or a boat too small to safely make it to civilization.

His findings for the construction of the lighthouses of Massachusetts were similar to his report on those of Maine.

In February 1843, Lewis submitted his report to Congress, through Secretary Forward. Secretary Forward included his recommendations with the report which stated, in part, that no further appropriations should be made for the erection of any lighthouse unless a competent engineer ascertained its necessity, determined the suitability of site, and provided a detailed plan and cost estimate for all buildings of the station. He also suggested that anytime repairs to any aid to navigation were estimated to exceed \$500, funds should be approved by the secretary of the treasury. Finally, he requested that the supervision of lighthouses be placed under a “competent and scientific engineer” who would be paid \$3,000 a year.

I.W.P. Lewis’s report was made with such vigor that Stephen Pleasonton’s rebuttal, made to Treasury Secretary Spencer (who had replaced Forward) characterized the report as

“these calumnies” and declared himself as “having been grossly misrepresented by him.”

Pleasanton wrote to Spencer:

Sir: The Light-house establishment within the states of Maine, New Hampshire and Massachusetts, and its management, having been grossly misrepresented by a man employed by your immediate predecessor to inspect the same, and these calumnies having been communicated to the House...I took [liberty] to instruct the ... superintendents, not only of these states, but in all the states bordering upon the Atlantic, to open books at their respective Custom Houses, and to ask the masters of ships and other vessels, as they visited the custom-houses to make entry, to enter in those books their several opinions as to the quality of all lights from Maine to Louisiana, and forward these books to me prior to the meeting of Congress at its present session.

Pleasanton went on to state that the “books” that he was forwarding contained the names of 1,000 masters of ships and other vessels who all attested to the excellence of the aids to navigation of this country. He also forwarded favorable testimony from the Marine Society of Portland, Maine, representing 1,400 ships and other vessels.

He added to this vote of confidence the following statement:

In the report [I.W.P. Lewis’s report] before alluded to, is an affidavit by one Daniel Bryant procured with a view of impeaching my character in connection with Mr. Winslow Lewis, who was employed by Mr. Bancroft to build three small lighthouses at Nauset Beach [Ed.: The Three Sisters of Nauset on Cape Cod]. Unfortunately for Daniel Bryant, there is not one word of truth in his disposition in regard to myself.

Pleasanton explained that Mr. Bancroft, collector of customs at Boston, was directed by him to advertise for proposals for the lighthouses (which had been approved by Congress), give the job to the lowest bidder, and appoint a mechanic to oversee the project and make payment if the job was well done. Winslow Lewis was the low bidder, something that happened with amazing regularity, and Daniel Bryant was appointed mechanic, or inspector.



Admiral William B. Shubrick served as the first head of the U.S. Lighthouse Board (as a commodore) from October 1852 until February 1859 and again (as a rear admiral) from June 1859 to October 1871. The first vessel constructed especially for the Lighthouse Service (1857) was named for him.

On July 30, 1838, Bancroft wrote to Pleasanton that the work was complete “and done in a manner to do credit to Mr. Lewis, and was the best work of the kind, probably, in my district.” On the same day Daniel Bryant certified that the contract had been fully complied with and Lewis paid.

However, four years later the December 2, 1842, affidavit of Bryant stated:

When the job was finished, I was called upon by the contractor to sign a certificate that the terms of his contract...had been honorably fulfilled. This paper I refused to sign, and referred the contractor to the collector at Boston...After a delay of some time, I received notice to call upon the collector at the Custom-house; and when I called there, I was directed to sign the certificate of approval before named.

When Bryant inquired as to why he should sign, the collector told him that the fifth auditor had accepted the work and that he should sign as a matter of form (it was just government paperwork). David Bryant did sign, thinking that his objection to the quality of the work was waived.

Pleasanton wrote that he never received a letter from Winslow Lewis, nor never wrote a line to Mr. Bancroft and that “This man, Bryant, will be indicted, and probably punished, for perjury in this case.” Things were heating up for the fifth auditor.

The names that he submitted in his defense did stay his “execution” for another eight years, but one has to wonder about the politics of the situation. Perhaps the collectors of the various ports had some influence over the local mariners. And many of the names were no doubt those of mariners who had never been

to Europe; they were names of pilots, coastal vessel operators, and fishermen who had never been to Europe, had never seen the “light,” and had nothing with which to compare the weak reflector system.

A prominent *Boston Journal* said:

The report that resulted from this partial survey was a severe blow to the defenders of the old [reflector] system; and if the Government had possessed the proper energy and vigilance, such an array of facts could not have been passed over unnoticed. A most important benefit, however, resulted to the public from the detail of the defective condition of the lighthouses, and particularly as to the illuminating apparatus contained in this report of Mr. I.W.P. Lewis; for it compelled the general superintendent of light-houses to bestir himself and ‘get things a little more to rights.’”

But Stephan Pleasonton wasn’t about to “get things a little more to rights.” The report and recommendations were tabled by Congress to the next session.

In June 1845 the new secretary of treasury, R.J. Walker, detailed Navy lieutenants Thornton A. Jenkins and Richard Bache to investigate the world situation. They were sent abroad “to procure information which may tend to the improvement of the light-house system of the United States; and as it is alleged that important improvements have been made in the light-houses of Europe, especially those of France and Great Britain, the Department wishes to understand fully what those improvements are, and if they are adapted to introduction in our country.” They were instructed to obtain information on the organization of the various systems, construction methods, lighting apparatus, costs, instructions to keepers, and even information on types of buoys used abroad.

After spending a

year abroad, the young officers submitted a report in June of 1846 that recommended the reorganization of the Light-House Establishment by the appointment of an engineer and optician and a number of district superintendents, under the direction of the secretary of the treasury. They recommended that the engineer would make the plans, drawings, and specifications for all construction work and inspect each lighthouse at least once a year. The optician would test illuminants and lens apparatus and visit each lighthouse once a year to make repairs and adjust the apparatus.

The coasts were to be divided into 10 districts, each placed in charge of an officer of the Navy who would inspect his lighthouses once a month and establish positions of aids to navigation by angles, bearings, etc., and make regular reports to the central office.

Secretary Walker submitted the very detailed report and recommendations to Congress stating: “The report of the inspecting officers detailed...to examine the lights of our coasts showed their absolute defects; the present report shows their deficiencies as compared with other countries. The trial made of one of the French lights [Keep’ – Fresnel lens] at Sandy Hook...has been very successful, but the use of this apparatus has not been extended.” The secretary noted that the law still required the old reflector system be employed. He went on to suggest that our system had grown to the point that one man could not attend to all the details

concerning construction, contractual matters, modern developments, and inspections...not to mention having the expertise to understand all the ramifications to navigation matters.

Secretary Walker thought that the formation of a board was the answer and that such a board might include the fifth auditor, the superintendent of the Coast Survey, two naval officers and two from the Army (a Corps and a Topographical engineer) and a junior Navy officer to act as secretary. He requested permission to appoint such a board.

Congress dragged its feet on this matter until March 1851 when suddenly an act was approved in which the secretary of the treasury was authorized to place Fresnel lenses in lighthouses “as rapidly as he thought best,” to appoint a board of proper persons to inquire into the condition of the establishment, to make a (yet another) detailed report, and to detail engineering officers from the Army to superintend the construction and renovation of future lighthouses.

On May 21, 1851, Treasury Secretary Corwin appointed the board, which consisted of Commodore W.B. Shubrick, USN (president); Commander S.F. DuPont, USN; General Joseph G. Totten, U.S. Engineers; Colonel James Kearney, U.S. Topographical Engineers; Professor A.D. Bache, superintendent U.S. Coast Survey; and Lieutenant T.A. Jenkins, USN (secretary). Finally, professionals were about to take charge of the aids

to navigation of this country. This ad hoc committee, in short order, submitted to the Congress a most comprehensive report of some 760 pages and 40 plates.

The report detailed construction of towers and dwellings, instructions as to how keepers were to perform their duties, ability and fidelity of the inspectors, mode of procuring and furnishing oil and other stores to the light stations, methods of testing supplies, and types

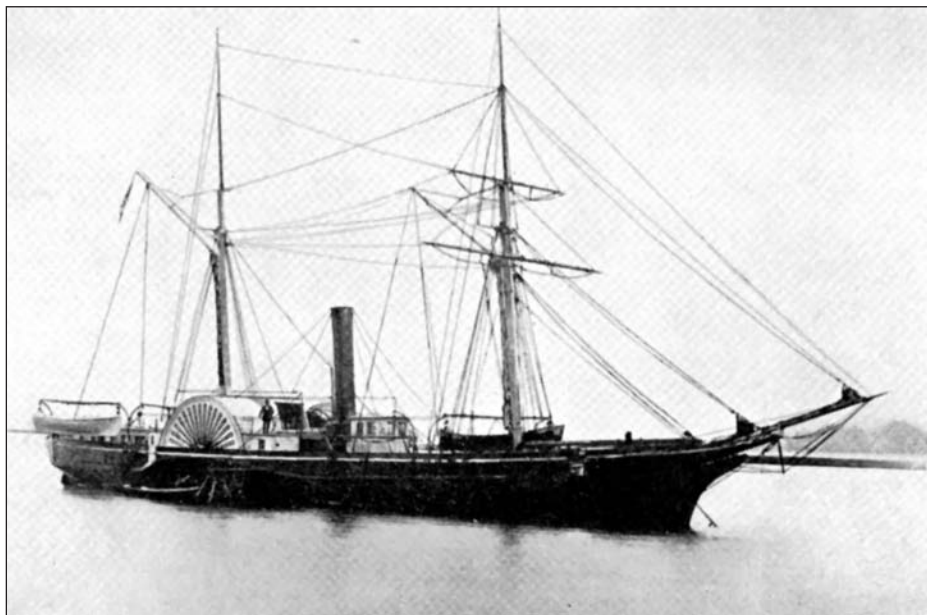

The lighthouse tender *Shubrick*. USLHS archive photo.

of reports to be placed into the new system. The report recommended that Fresnel lenses be placed in all of our lighthouses and that they be classed by order, like the French (first order being the largest and sixth the smallest). Every aspect of construction, inspection, and administration was laid out in fine detail.

The report also recognized Pleasonton, who had administered the lighthouse service for over 30 years, a period in which the number of lighthouses had grown from 25 to well over 300. They said “great credit is due to the zeal and faithfulness of the General Superintendent and to the spirit of economy which he has shown,” which spirit, perhaps, accounted for the “lack of zeal exhibited for the adoption of modern improvements”; and went on to say that, really, it was too much to expect that one person had the ability to manage such a vast organization and to stay on top of all the new developments, as well as ensure that all aspects of the service were running smoothly.

Both houses passed this organic act and on August 31, 1852, it was signed by the president. The ad hoc committee became the U.S. Light-House Board and would hold sway for the next 58 years.

The secretary of the treasury was to be president but, in his (usual) absence, a chairman was chosen. Commodore Shubrick was named the first chairman. Joining him on the board (along with those appointed in 1851 to the board of inquiry) were Professor Joseph Henry, secretary of the Smithsonian Institution, and Captain E.L.F. Hardcastle, USN, as engineering secretary. Shubrick served on the board, with some breaks, for 19 years, and Professor Henry was chairman for seven years.

Other respected civilians who served on the board during this important period of lighthouse development were A.D. Bache, Mendenhall and Pritchett (all one time superintendents of the Coast and Geodetic Survey) and Henry Morgan, president of the Stevens Institute.

Notable Navy officers were Jenkins, Dewey, Evans, and Schley. The Army Engineers was represented by Totten, Humphreys, Franklin, Poe, and Casey. Meade, in later years in command of the federal troops at Gettysburg was engaged in lighthouse construction for six years in Delaware and Florida where he constructed Sombrero and Sand Key lighthouses, the first of the giant Florida reef structures.



Professor Joseph Henry. USLHS archive photo.

Other board officers that later served the Confederacy were Commander Semmes and Generals Rosecans and Beauregard.

The Lighthouse Board took up its duties immediately upon being organized. As instructed by the act, they divided the coasts of the country into 12 districts: seven on the Atlantic, two on the Great Lakes, two on the Gulf, and one on the Pacific. At first an Army or Navy officer was assigned as inspector. Later each district would have a naval officer as inspector and an Army Corps of Engineers officer as engineer.

The board took immediate steps to replace all reflector systems with Fresnel lenses, and by 1859 the substitution was nearly complete. The contract for the first eight lighthouses for the West Coast had been awarded in 1852, and the board immediately sent a change order to the contractor deleting the reflector system from the contract. The West Coast lighthouses were to have Fresnel lenses from the beginning.

This was also the era in which the price of sperm whale oil skyrocketed. At first, following the lead of Europe, the Lighthouse Service substituted colza oil (a wild cabbage) for whale oil to fuel the lamps. But our farmers could not be enticed to grow this crop in ample amounts and the service employed lard oil as the principal illuminant. The 1850s also saw the development of several types of fog signals;

invention of the bell buoy; construction of the first Lighthouse Service tender, the *Shubrick*, which was assigned to the West Coast; codification of a uniform system of buoyage; and streamlining of the *Notice to Mariners*.

Lighthouses in the southern states suffered badly during the Civil War. A great many were partially or totally destroyed. In some cases the Confederates removed the lenses from the towers, hiding them until after the war was over. Nearly all the lightships in the Chesapeake were taken or sunk to obstruct various channels. Some 164 lighthouses were, in one way or another, placed out of commission during the hostilities. The management of the service also suffered as naval and Army officers were reassigned to the military duties. The board tried to cooperate with the naval forces by relighting as many towers as was possible.

In 1862 a bill was introduced into the Senate to transfer the Lighthouse Board to the Navy department. The secretary of treasury asked Admiral Shubrick his opinion of this proposal, and Shubrick shot back that one need only to look at the progress made between 1852 and 1862 as compared to the situation prior to 1852 to see the folly of this reorganization. The bill failed.

Another attempt was made in the period 1882-1885. This proposal would combine the Lighthouse Service with the Life Saving Service and Coast Survey and transfer that amalgamation to the Navy. The secretary of the Navy argued that those three services were maritime in nature and had no relationship to the Treasury...but the reorganization was thwarted.

In 1874 Congress extended the jurisdiction of the Lighthouse Board over the Mississippi, Missouri, and Ohio rivers, providing for such “beacon lights, day-beacons and buoys as may be necessary for the vessels navigating these streams.” The act also provided that the rivers be divided into two (new) districts. The first light in the river districts was established at Jefferson Barracks, near St. Louis, Missouri, in December 1874.

In 1883 several severe shipwrecks in Alaskan waters caused the board to establish 14 iron buoys in the new territory. However, Alaska wouldn't get its first lighthouse until after the turn of the century.

On July 26, 1886, Congress authorized an increase in lighthouse districts to 16; the rivers were now divided into three districts

and by this time the West Coast had two (California and the Pacific Northwest).

A Presidential Executive Order on May 1, 1900, placed the Puerto Rican Lighthouse Service under the Lighthouse Board. Several requests were made during this era for an increase of the districts from 16 to 18 so that Puerto Rico and the Dutch West Indies could be districts. Requests were also made to provide for the Hawaiian lighthouses, should they be transferred to the U.S. Lighthouse Service. Although there were some aids to navigation in Alaskan waters (which were under the Pacific Northwest District), no lighthouses had been constructed. On January 1, 1905, Hawaii lighthouses and aids to navigation became a subdistrict of the 12th (California) District. Later that year the Midway aids to navigation joined Hawaii under the 12th District with Guam and the Samoan islands following suit in 1905.



Lighthouses Transferred to Commerce

The Department of Commerce was created by an act on May 14, 1903. A provision of the act required the transfer of the Lighthouse Board from Treasury to this new department. The Lighthouse Board, by this date, had been in existence for over 50 years and had not only increased the number of aids to navigation in the country, but had carried out some notable and difficult lighthouse construction (Minots Ledge, Tillamook Rock, and St. George Reef, to name but a few).

Bureau of Lighthouses Created

In June of 1910, Congress passed an act that reorganized the Lighthouse Service. The

Lighthouse Board had now been in control for 58 years. Total lighted aids had increased from around 335 when the board assumed control to nearly 4,000 (this includes minor lights and lighted buoys). Fog signals had increased from 49 to 457, and buoys from 1,000 to 5,300. The board which had been necessary to oversee a system too complex for one man had now, itself, become obsolete.

Congress now thought that a pyramid structure was necessary with a single bureau chief at the top of the pile. We had come, in a way, full circle. Congress also felt that assigning military officers as engineers and inspectors of the districts (for short periods of time) caused the loss of continuity. The assignment of a civilian inspector, who would hopefully serve for many years, would provide continuity.

The Organic Act of 1910 authorized that civilian personnel manage the system, and a period of three years be used to implement the new system. Further, it increased the number of districts to 18 to establish separate districts for Puerto Rico, Hawaii, and Alaska. In the future each district would be managed by a single head, a district inspector (in 1918 this title was changed to district superintendent) who answered directly to the commissioner of lighthouses on all matters relating to his district. Each district was staffed with an associate, a clerk, and an engineer.

George Putnam, who had a long and distinguished career with the U.S. Coast and Geodetic Survey, was appointed the first commissioner of the new bureau. He would reign until May 31, 1935, when he was forced to retire due to age. Prior to assuming control over the Lighthouse Service, Putnam was director of the coastal surveys of the Philippines. Once appointed to the new bureau, he took firm control and instituted not only the new administration but many changes as technological advances were developed, among them radio beacons. At his retirement luncheon, Secretary of Treasury Roper congratulated Putnam on his distinguished career of 45 years and noted that while aids to navigation had increased from around 12,000 to 24,000 during his tenure, the number of employees dropped from 5,832 to 4,980. Putnam was replaced by H.D. King, who headed up the bureau until the Coast Guard assumed control in 1939.

President Roosevelt's Reorganization Order #11 consolidated the Lighthouse Service with the U.S. Coast Guard to take



effect on July 1, 1939. It read: "Bureau of Lighthouses—the Bureau of Lighthouses in the Department of Commerce and its functions are hereby transferred to and shall be consolidated with the administration of the Coast Guard in the Department of the Treasury." And, thus, lighthouses were back under Treasury again.

After the reorganization the keepers had several options: (1) Quit, (2) Retire (if they had enough time in service), (3) Remain a keeper (wearing the USLHS uniform), or (4) Transfer into the Coast Guard at an applicable (lateral) rate. Keepers who transferred were given a petty officer rank that equaled the pay they were then drawing; a head keeper might become a 1st class, an assistant 2nd or 3rd, etc., and most keepers were given a boatswain mate rating. While some personnel remained "keepers," there was an advantage to transferring to the Coast Guard. The storm clouds of WWII were gathering. Because keepers were Civil Service, they were eligible for the draft.

During the 1960s, when automation was in full swing, light stations were a strange mix of civilian and enlisted Coast Guard. By this period the few keepers remaining from the Lighthouse Service had acquired seniority and knowledge, to the extent that they were head keepers of the manned stations to which they were assigned. They were provided two or three young Coast Guardsmen to assist in running the station. By the late 1970s, all civilian keepers had retired with the exception of Frank Schubert, keeper of the Coney Island, New York, station. Also by the end of the 1970s, most light stations of this country were unmanned, less than



The Rose Island (Rhode Island) Lighthouse, in 1985, was deserted and left to the elements before preservation efforts brought it back (bottom photo). USLHS archive photos.

10 remained at the start of 1989, and this number will dwindle to zero within the next few years.

After 273 years, the era of manned lighthouse in this country is fast approaching an end. That unique way of life will pass as surely as has the era of the tall ship and steam locomotives. Somewhere, in a remote area of Canada or perhaps India, people may still be assigned to a lighthouse to fulfill the role of weather watcher or to assist with a remote communications link. And there will be stations, constructed long ago in the age of steam and clipper ships, where a scientist will reside to study and manage our wildlife. But the era of the manned light station is soon to end, and the Golden Age of lighthouses (the 19th century) has passed.

Modern inexpensive electronics (both ashore at major sea coast lights and aboard all size vessels) have obviated the need for people to tend the flame, record weather, and watch for vessels in distress.

As our civilization progresses, we move two steps forward...and sometimes one step backwards. In the area of convenience, cost of goods and their availability, health and creature comforts, we continue to gain...in matters of a slower paced way of life and the

personal touch, we sometimes lose—ebb and flow. Progress continues but, for us, a quaint, unique and altruistic way of life has passed over the horizon.

Update 2014

These last two paragraphs were written back in 1989. At the time the national lighthouse preservation movement was just beginning. Since that time, people and groups in many areas of the nation have come together in a variety of ways to restore and preserve our historic light stations. And since that time there has been a ground swell of preserving old train stations, covered bridges, city halls, and other structures.

Since 1989 all American light stations have been automated, (Boston Harbor retains a symbolic keeper), the Historic Lighthouse Preservation Act of 2000 has been passed, many stations and lightships have been restored, or are undergoing restoration, a new National Lighthouse Museum has opened on Staten Island, New York, and mariners now have GPS to assist in navigating the waters of the world.

While we can't save every vestige of our nautical past, we have made a significant contribution to preserving many elements of our maritime heritage for the future.





Join the U.S. Lighthouse Society Today
or
Give the Gift of Membership!



Restoration & Preservation



Thomas Point Shoal Lighthouse, MD

In 2009 the U.S. Lighthouse Society donated to many lighthouse preservation projects throughout the U.S. Most recently we were presented the Preserve America Stewardship Award from The White House for our restoration work at Thomas Point Shoal Lighthouse.

Help Support Our
Important Mission!

Education



The Keeper's Log magazine celebrated its 25th anniversary in 2009. Receive this award-winning publication quarterly as a benefit of membership.

The Society organizes domestic and international lighthouse tours. Many of our excursions gain access to lighthouses not normally open to the public. These trips are a great way to have fun, see lots of lights and learn about lighthouse history.



Tincum Lighthouse, NJ

*To learn more
visit www.uslhs.org
or
call Headquarters at
415-362-7255*



The Keeper's New Clothes

By Wayne Wheeler

Reprinted from Vol. XVIII No. 1 (Fall 2001) Keeper's Log

the top ones placed close to the collar and the bottom ones six inches from the bottom hem, the others equal distance between them. The length of the coat to be the extended arm and hand; the coat to be provided with two inside breast pockets and two outside hip pockets; the latter to have flaps so arranged to be worn inside the pockets if desired. Each sleeve to have two small buttons on the cuff seam, 1/2-inch apart, the lower button one inch from bottom of cuff.

The vest to be of navy-blue cloth in winter, or navy-blue serge or flannel in summer, and cut single-breasted, with five small regulation buttons and a small rolling collar, so as to show about 6 inches of the shirt bosom; to have a watch pocket in the left side and a lower pocket on each side.

The trousers to be of navy-blue cloth in winter, or navy-blue serge or flannel in summer, cut in the prevailing styles, with pockets in hip seams.

Cap to be of the navy pattern, with adjustable chin strap of gold lace 1/2-inch wide, fastened to the sides by small regulation buttons; in the middle of the front of the cap a gold embroidered wreath 1 1/4 inches high by 2-inch spread, enclosing a silver embroidered light-house 3/4-inch high; a black mohair braid 1 1/2 inches wide to be worn around the cap.

The regulation went on to describe the sleeve ornaments and overcoat. The regulations further described the uniform requirements of individuals assigned to lighthouse tenders (mates, engineers, clerks, etc.), personnel on lightships (similar to tender personnel). The instruction delineated the differences between the uniforms assigned to keepers from those of the vessel personnel.

Keepers of lighthouses to wear

the same uniform as the masters of tenders, except the ornaments on the sleeves of coat. They will wear on each lapel of sack coat a loop embroidered in gold, 2 1/2 inches long by 3/4-inch wide, the border of the loop to be 1/10-inch broad. If principal keeper—the letter "K" will be worn within the loop. The first assistant keeper—the figure "1" will be worn embroidered within the loop. The second assistant keeper—the figure "2" will be worn embroidered within the loop...

Lighthouse and Buoy Depot Personnel

The regulation next directed the keepers of the lighthouse and buoy depots to wear the same uniform as the principal keeper of lighthouses, but described a completely different uniform:

...to wear a single-breasted sack coat of navy-blue cloth in winter, or of navy-blue flannel in summer, cut after the pattern of the army blouse, with a turn-over collar 1 1/2-to-2 inches deep, buttoned up to the throat, with five large regulation buttons on the right side, the top button just below the collar seam, the other buttons equally spaced between the top button and the bottom button. The letter "W," 3/4-inch high, worked in gold, enclosed in a gold embroidered loop of same dimensions as worn by light-house keepers, to be worn on each of the collars, 1 inch from bottom.

The vest was the same as described for the keepers as was the pants, although called pantaloons.

The captain of the watch to wear the light-house in gold embroidered wreath. Belts to be of adjustable black leather, 2 inches wide, with gilt clasps, on which in raised letters to have the word "Police." When overcoats are

In 1883 the Lighthouse Board prescribed dress and fatigue uniforms for keepers and personnel assigned to Lighthouse Service tenders and lightships.

Until this requirement, there was no uniform. From 1789, when the federal government established the Lighthouse Service, until the period 1884-1885, keepers at light stations wore just about what they pleased. The board stated, "It is believed that uniforming the personnel of the service, some 1,600 in number, will aid in maintaining its discipline, increase its efficiency, raise its tone, and add to the esprit de corps."

Lighthouse Keepers and Persons Assigned to Vessels

On May 1, 1884, the following regulation went into effect:

The uniform for male keepers and assistant keepers of light stations, and the masters, mates and engineers, and assistant engineers of light vessels and tenders, will consist of coat, vest and trousers and a cap or helmet. The coat will be double-breasted sack with five large buttons on each side—

Keepers and assistant keepers

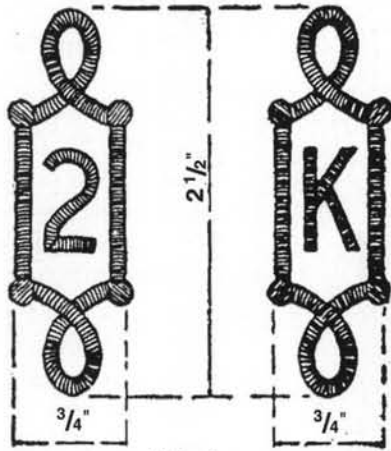

K for keeper

- 1 for first assistant keeper
- 2 for second assistant keeper
- 3 for third assistant keeper
- 4 for fourth assistant keeper

Regulation Buttons for General Service
To be triple gilt on brass



Insignia in rectangle with loops denoted rank

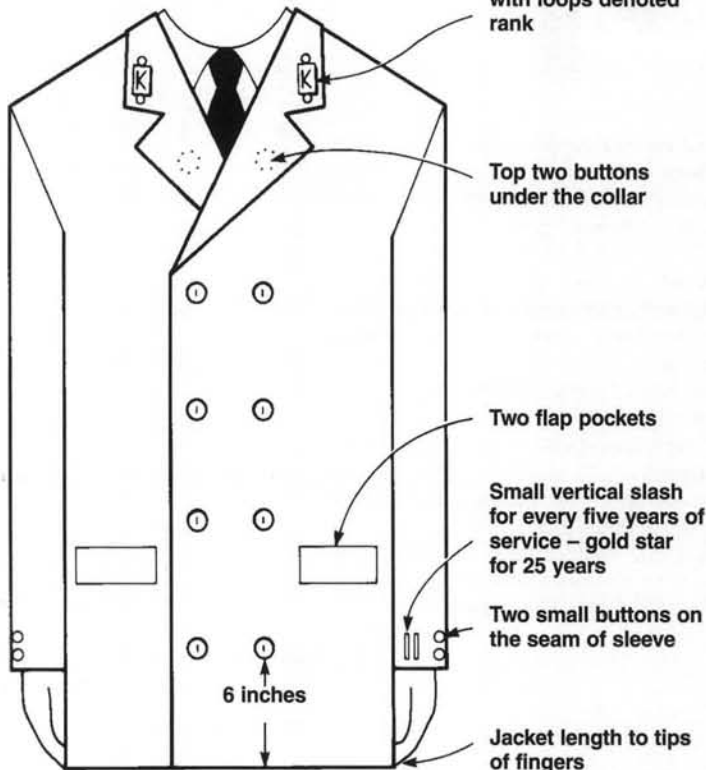

worn the belt will be outside, with a leather stall to carry the club.

The shield shall be the same as that worn by the police of Richmond County, NY [Staten Island]. To be worn on the left breast of the [coat].

Hats to be of the helmet pattern, of blue in winter or light brown linen in summer. The helmet to have a black glazed, 1/2-inch leather strap in front secured on each side by small regulation buttons and have one gilt buckle on each front quarter. To have a gilt metal lighthouse 1 inch above the chin strap in the middle of the front, with a whistling and spar buoy crossed.

This cap emblem description is often mistaken for a lighthouse keeper emblem. It could be that a depot watchman was later assigned to a light station and retained the unauthorized emblem, rather than purchasing the emblem required for keepers; a wreath surrounding a lighthouse.

Buttons

Regulation buttons for all personnel were described as "Buttons to be triple gilt on brass. The outer rim to be slightly raised, inside of which, arranged circularly, are to be the letters U.S.L.H.E. [E standing for establishment]. There will be three sizes of buttons: Large, 1-inch in diameter; Medium, 3/4-inch in diameter; Small, 1/2-inch in diameter. The medium button to be worn on serge or flannel suits."

When to Wear Them

The regulations stated that all males employed on ships or stations shall wear the uniform prescribed at all times on duty, and when visiting the Light-House Board's office or the inspector's or engineer's office, they will always appear in proper uniform. Laborers employed to care for river or post lights are not required to wear the uniform. All keepers and other employees, when cleaning lamps or lenses, will wear aprons provided and issued. Engineers, in repairing or cleaning machinery of vessels, may wear the overall suit prescribed to save the uniform. The measures for uniforms of the Light-House employees are subjoined, and employees are authorized to have the uniform made wherever they may prefer; but all uniforms must conform to the regulations herewith established. Officers are forbidden to wear

any part of their uniform with citizen clothes, except the cap and overcoat. In foul weather officers and crews will be permitted to wear rain clothes.

Signed, Jas. A. Greer, Rear Admiral, U.S. Navy, Chairman

The 1885 *Report of the Lighthouse Board to Congress* noted, "The Board has succeeded in clothing all the male light-house keepers, and the officers and crews of light-ships and light-house tenders, in a neat, appropriate, and economical uniform, which the laborers employed as acting light-house keepers are not allowed to wear."

The Lighthouse Service paid for the initial outfitting of all 1,600 keepers at the 673 lighthouses existing in 1885. After this period the keepers were to pay for their own uniforms. The Twelfth District (California) inspector issued Circular No. 12 in 1888:

You are informed that the regulation uniform for light keepers can be obtained from C.S. Fechheimer Plaza Stores—706 to 720 Kearny Street. The following is a comparison of the prices charged in Philadelphia and San Francisco, expressage (freight) not included. When ordering, keepers are directed to state on the blank form whether they wish their clothing to be made in Philadelphia or San Francisco.

Signed, Nicoll Ludlow, Cdr, U.S.N.

The circular listed prices of uniform items in both cities. A coat was \$9.75 in Philadelphia and \$11.50 in San Francisco—trousers \$5.50 versus \$7.50. A uniform consisting of hat, jacket, vest, pants, buttons, and collar devices cost \$22.25 in Philadelphia versus \$26.25 in San Francisco. In today's money that uniform would cost \$568 in Philadelphia and \$670 in San Francisco. A 3rd assistant keeper in 1888 made \$500 a year. A uniform purchased in San Francisco equaled over two-and-a-half weeks salary, and those prices didn't include black shoes, shirt, or tie. Percentage-wise a complete uniform equaled about three weeks pay, and they also had to purchase a work uniform.

One can imagine that some keepers may have taken slowly to wearing their new clothes and that some confusion must have initially existed about when and where to wear the uniform.

In 1887 a circular was distributed to light stations:

Sir: Your attention is again called to the regulations of the Light House Service in regard to wearing the uniform:

SMITH-GRAY, NEW YORK



Above: A romanticized version of a keeper in his uniform from the Smith-Gray Company catalog of New York City, "Outfitters to every Branch of Public and Private Service."

A forward in the brochure proclaims, "Experienced Lighthouse men prefer Smith-Gray custom-made uniforms for three good reasons:

- (1) The quality of cloth and trimmings.**
- (2) The correctness of fit and style.**
- (3) The low prices-quality and good tailoring considered.**

To these we have now added a fourth good reason: FREE DELIVERY.

Therefore, all cash orders for \$25.00 or more ...will be delivered FREE to any point in the United States (but not Alaska)."

Under penalty of dismissal, keepers are required to wear uniform at all times on the reservations.

Citizen's clothing may be worn by keepers while off the reservation on private business. The wearing of part citizen's clothing and part uniform is strictly prohibited at all times, either the fatigue uniform or the dress uniform must be worn—the wearing of part fatigue and part dress is also prohibited. Fatigue uniform must be kept clean and no keeper will be allowed to wear dirty clothing at any time [must have been hard to do carrying coal sacks from the dock up to the fog signal building!].

The quarters are to be kept in good order, the paint work and floors free from dirt, and the walls free from cobwebs, soot, etc.

The regulations of the Board as to the color of paints used in quarters must be strictly adhered to and no deviation therefrom will be permitted.

Principal keepers are required to see these orders enforced, and to promptly report to the Inspector any violation of them.

Nicoll Ludlow, Cdr, U.S.N., Inspector.

It is interesting to note the words "male keepers" in the early uniform regulations. No uniform was ever designed for female keepers, and there were numerous female lighthouse keepers. Emily Fish, keeper of the Point Pinos, California, lighthouse, designed her own uniform.

Circular No. 2 of 1894 stated, "The effect of this amendment is to do away with the gold band on [the] cap now worn by light house keepers." After this date the chin strap on a keeper's hat was black leather, but remained gold on the hat worn by ships' officers.

The uniform regulations issued in 1907 paralleled earlier regulations, except they furnished more details about a warm weather uniform, which consisted of a white, single-breasted coat with a high, stiff collar and five white, flat buttons, blue trousers, and a hat with a white cover.

The *Annual Report* of the commissioner to the (new) Bureau of Lighthouses in 1912 stated:

To promote efficiency and friendly rivalry among lighthouse keepers, a system of efficiency stars and pennants has been established. Keepers who have been commended for efficiency at each quarterly inspection during the year are entitled to wear the inspector's star for the next year, and for those who receive



Just a few of the many variations of the cap emblem on display at the Maine Lighthouse Museum, Rockland, Maine. USLHS archive photo.



An actual button from a keeper's uniform. USLHS archive photo.



A Statue of Liberty Enlightening the World Light Station keeper with a rather formal shirt and tie. USLHS archive photo.



Left: Three Great Lakes keepers. The flanking keepers have their rank insignia on the upper part of the lapel. The seated keeper, on the lower half. The keeper on the right has only six buttons showing; there should be eight. The lapels of the keeper on the left are too large. USLHS archive photo.

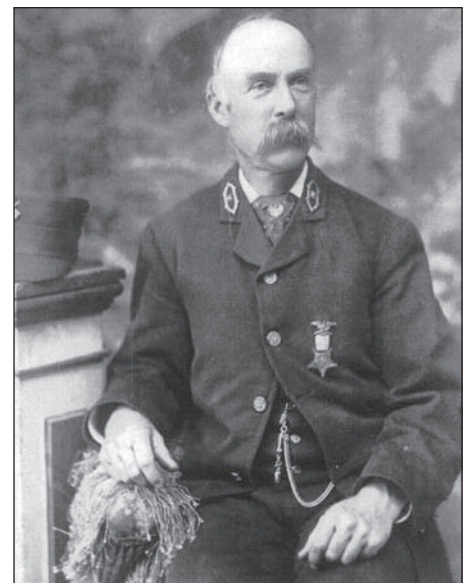

Right: When it comes to creative uniforms, this Maine keeper wins hands down. The coat is single breasted (in lieu of double), the enclosure around the lapel "K" is rather elaborate and without the prescribed loops, the middle button of the jacket is nonstandard, and the cravat is certainly one of a kind with an unauthorized tie pin. The medal on his chest appears to be a Civil War award, possibly Army due to the crossed cannons below the eagle.



One adaptation of a keeper's hat after the Coast Guard took over. USLHS archive photo.

the inspector's star for three successive years will be entitled to wear the Commissioner's star. The efficiency pennant, being the regular lighthouse pennant, is awarded to the station in each district showing the highest efficiency for a year, and may be flown during the succeeding year.

In 1913 a circular stated, "New buttons have been designed and Keepers, when next ordering, should see that they obtain the proper buttons for their uniform." We believe this was the year that the originally designed buttons with the initials "U.S.L.H.E." were replaced with the buttons showing a lighthouse in the water—similar to Minots Ledge.

New regulations were issued in 1920. The basic uniform remained unchanged but service stars and bars were added.

Gold service stars and bars, to indicate length of service, may be worn on left sleeve, the proper number of bars and stars being worn to represent length of service (one star to represent 25 years' service), the bars to be placed



Although there were numerous female lighthouse keepers over the years, no official uniform was ever designed or issued. Emily Fish, above, keeper of the Point Pinos Light Station in California, designed her own uniform.

vertically in a row, bottom of bars to be 2 inches from edge of sleeve, and star to be directly above bars. Bars to be 3/16-inch wide by 7/8-inch long, 1/2-inch center to center; stars to be 7/8-inch in diameter. Efficiency stars shall be worn on the left hand lapel of the coat or vest, as preferred.

The 1928 regulations only concerned the keepers in that "Working uniforms, similar to those prescribed for seamen on vessels, may be worn when required by the nature of the work [i.e. dirty]." Also, the collar was eliminated from the vest.

In 1939 the Lighthouse Service became part of the Coast Guard. The civilian keepers had several options. If they had enough time in grade they could retire, they could resign, they could remain a civilian keeper, or they could lateral into an applicable Coast Guard rate. A head keeper entered as an enlisted 1st class or chief petty officer (depending on his length of service and qualifications). In 1941 the Coast Guard issued regulations for Uniforms for Civilian Employees. Except for the new cover,

the regulations were a duplicate of the most recent Lighthouse Service regulations.

Initially, braces or suspenders held up the keeper's uniform pants. In fact, belts were never worn for most of the 19th century. Craig Nannos, of the *Sentry Post* and a uniform expert, states that belt loops began to appear on the uniforms of a few officers during the Spanish-American War but did not become official until 1902. From that year on, for many years, most trousers were furnished with buttons for braces as well as loops for belts. The next time you watch a Civil War or 19th century western, see if the actors are wearing belts. If so, they are not historically accurate. And, of course, zippers didn't appear until after WWII, so our keepers always had button flies.

For most of our history, either the Army Quartermaster Corps or a similar Navy department approved all government uniforms. Usually companies authorized to manufacture military or government uniforms were periodically inspected to ensure they conformed to the regulations. However, with all the regulations and quality control checks, uniforms were anything but uniform. Photographs in our files show various designs for the cap emblem, as well as some keepers with a four-in-hand tie and some with bow ties. We have a photo of three keepers where two have their rank emblem on the lower half of the lapel and one has it on the upper half—and these irregularities add to the rich and colorful history of our nation's lighthouse keepers.



Hat badge for Lighthouse Service Depot watchmen. There was a similar badge for the breast of the uniform. Lighthouse keepers did not wear this, or any, badge. USLHS archive photo.



YOUR LEGACY



FOR GENERATIONS TO COME



ALL YOU HAVE TO DO IS WILL IT.

Just by including the U.S. Lighthouse Society in your estate plans, you can help to ensure that lighthouses will be here for future generations. **A bequest is a simple way to support the Society** in the future while retaining control of your assets during your lifetime. We can be named as a beneficiary of your will, trust, retirement plan, life insurance policy or financial accounts. **The real beneficiaries, of course, are the lighthouses you love.** Please consult your financial advisor.

For more information about how to make a bequest to the Society, please contact Headquarters at (415) 362-7255 or email info@uslhs.org

The History of Fog Signals

By Wayne Wheeler

Reprinted from Vol. VI No. 4 (Summer 1990) and Vol. VII No. 1 (Fall 1990) Keeper's Log

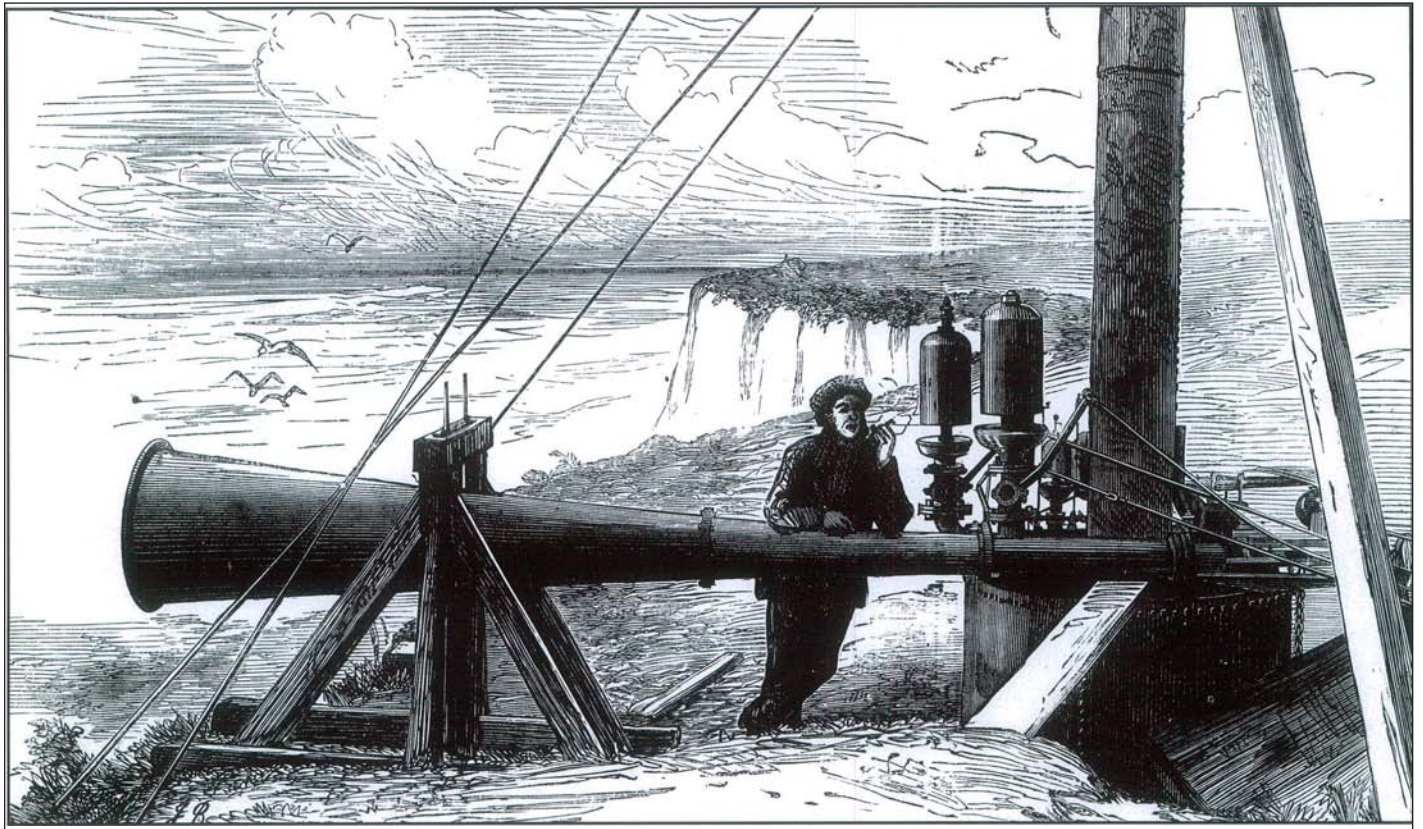

A reed trumpet with two locomotive (back up) whistle fog signals on the Scottish coast. USLHS archive image.



eeeohhhhh, the mournful sound of the fog signal hooting and echoing across a bay shrouded in gray. It seems as though that sound must have always been part of the bayscape. But, in fact, fog (correctly termed, sound) signals are relative newcomers to the field of navigational aids, and the most popular of them, the diaphone and diaphragms, are of the 20th century.

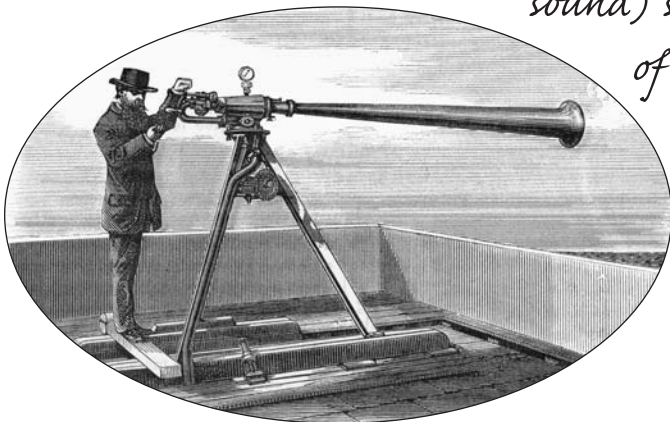

A Nebelhorn fog signal. USLHS archive image.

Since the mighty Pharos of Alexandria, Egypt, (circa 280 B.C.) mariners have had, after a fashion, a light to guide them into port or clear of dangerous reefs. Although the light signal from lighthouse towers left much to be desired until the 18th century, there was some sort of light to guide the seafarer. But light, no matter how powerful, cannot penetrate fog and other conditions of reduced visibility.

The navigator also relied on stars when at sea. Celestial navigation gave him an idea within a mile or two of his vessel's location. Certainly not adequate when running close to shore, but sufficient for crossing the ocean. The early mariner also had his lead line to assist him navigate into the ports of the world. When a ship approached a restricted channel or harbor entrance, the leadsman constantly cast a leadline which gave the navigator, pilot, or captain a running commentary on the depth of the water. In the bottom of the lead was a depression filled with tallow. The tallow picked up bits of shell, small rocks, sand and other items from the bottom. The mariner or pilot familiar with an area could tell, more or less, where he was in a channel by the type of evidence stuck to the tallow. Although not an exact science, it was better than nothing during period of reduced visibility prior to fog signals.

When reduced visibility set in during the days of sail, the mariner at sea, unable to see his stars, had only dead reckoning upon which to rely. Near shore he listened for the crash of surf, used his lead line, and often dropped the "hook" until visibility improved.

The propagation of sound is not a constant, especially during periods of fog. Cold and warm layers of air cause sound to deflect, skip, bounce, echo, and sometimes stop cold. The sound from a fog signal might be heard at one mile, not at two miles, and again at three. A mariner thinks he hears a fog signal from one direction, when in fact it originated some 45 degrees to the right...or 30 degrees to the left. And distances cannot be determined with any accuracy. Not only is it hard to tell the distance one hears a signal, it is impossible to predict that a signal can be heard at a certain range.



Above left: Sergeant Mahony's siege gun, the first fog signal on the West Coast, sometime prior to 1877. The lantern room of the Point Bonita Lighthouse, seen at upper right, was relocated to a lower elevation in 1877. USLHS archive photo.

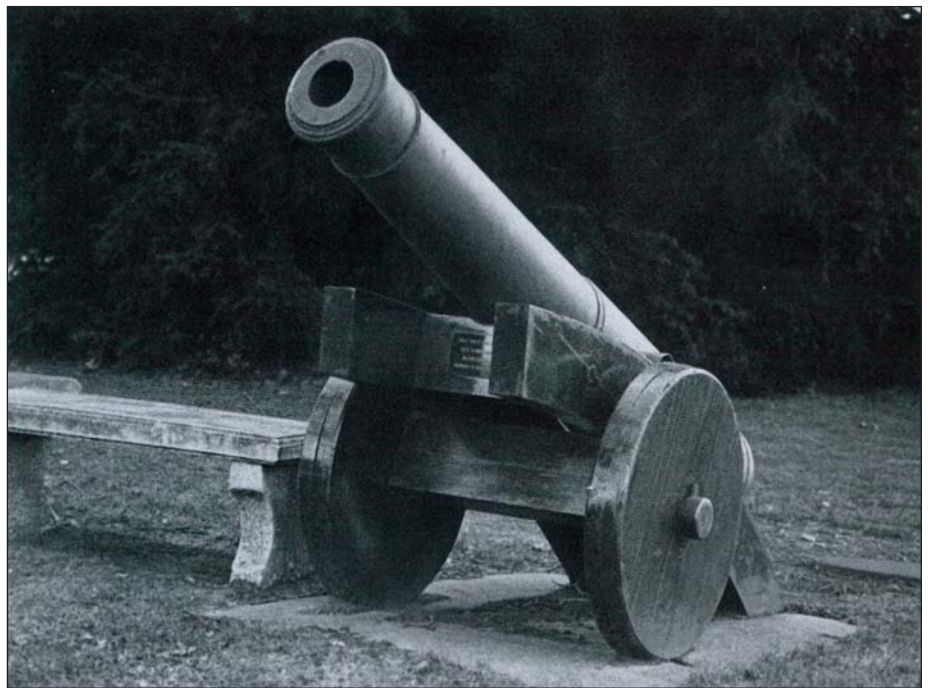

Above right: America's first fog signal which was used at the Boston Lighthouse beginning in 1719. It is presently on the grounds of the U.S. Coast Guard Academy, New London, Connecticut. U.S. Coast Guard photo by Paula Hobson.

A signal "rated" for four miles might be heard at only two miles or, given the right atmospheric, eight miles.

Navigating by sound is less than ideal and, often, a tricky way to maneuver during reduced visibility. Still, until the advent of onboard electronic navigation equipment (radio direction finders, depth finders, radar, and LORAN), sound signals were the mariners' best friend during periods of reduced visibility...and certainly of more assistance than groping along with only the information supplied by a lead line.

The first fog signals were rockets and cannons (or fog guns) developed in Europe in the 18th century. The first fog signal in this country was a cannon, which was installed at our first light station, Boston, in 1719. Ships entering Boston harbor fired a cannon and the keeper responded in kind. This gave the mariner a fairly good idea of the direction of the Boston Lighthouse. Rockets were never employed in this country. A fog gun was also used at West Quoddy Head, Maine. It was a carronade, five feet long with a bore of 5¼ inches and charged with four pounds of powder. The gun was fired on foggy days when the Boston steamer approached the station from St. John. They began firing the gun when they heard the steamer's whistle, usually about six miles off. They continued firing the gun as fast as they could load it until the steamer answered with her whistle, somewhere around two miles.

In later years Professor Henry of the Lighthouse Board stated, "The gun was abandoned because of the danger attending its use, the length of interval between successive explosions and the brief duration of the sound, which renders it difficult to determine its direction with accuracy."

The first fog signal on the West Coast was also a gun. In 1857 the

service installed a 24-pounder at Point Bonita, hired a retired Army sergeant, and instructed him to fire it on the half hour during periods of fog. Armed with his marching orders Sergeant Mahony set about his task. What the service didn't know was that Point Bonita experienced over 1,000 hours of fog or "thick" weather a year. In short order the district office received a letter from the good sergeant stating, "I cannot find any person here to relieve me, not five minutes. I have been up three days and nights and had only two hours' rest, and am nearly used up. All the rest I would require in the twenty-four hours is two, if I could only get it." During the first year he fired 1,390 rounds, expending 5,560 pounds of black gun powder at a cost of \$1,487. The district did send him an assistant, but in the second year of operation there were 1,582 discharges expending \$2,000 of black powder, three times the sergeant's salary. So by the end of that year the signal was discontinued.

The next type of signal consistently used in this country was the bell, at first rung by hand. In 1837 the service had experimented with a metal triangle at the West Quoddy Head Light Station. It was constructed of a metal bar $2\frac{3}{8}$ by $14\frac{1}{2}$ feet, bent into shape, and rung by hand... it was not a success.

One can well imagine what a chore it was to ring a bell signal by hand in areas of the coast where fog lasted for days on end. Responding to the need for an automatically rung bell, Andrew Morse, Jr. developed the "perpetual fog bell" and installed it at the Whitehead Lighthouse at the entrance to Penobscot Bay, Maine, in 1839. This was an elaborate device consisting of a "boom" floating in the surf, which rose and fell on the swells causing weights of 2,000 pounds to be wound up. The descending weights drove both the regulating and striking apparatus. The striking and regulating part of the device worked fairly well, but the "boom" was often torn apart by the sea, and the signal was soon discontinued.

Although this clockwork device was unsuccessful, it was the predecessor of the eventual clockwork mechanism powered by a descending weight that was introduced in the next few years. Three of the primary manufacturers of bell strikers were Gamewell, Stevens, and Daboll. The first two were town and church clock manufacturers and the third, Celadon Daboll, an inventor of other sound signals.

The Rube Goldberg looking clockworks (about the size of a pedestal sewing machine) was powered by a descending weight dampened by a governor. When a cam dictated, a heavy spring released a



Because the weight cables of the first Alcatraz fog bell (below) kept falling, a second house with a weight tower at the rear (above) was constructed. USLHS archives.

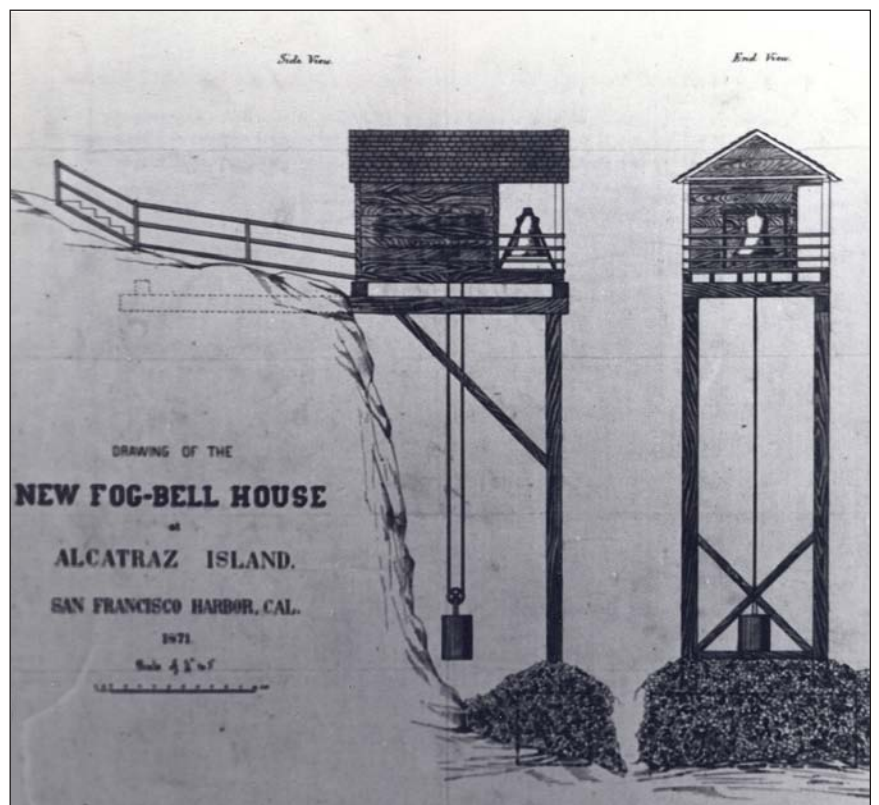

sledge hammer which struck a bell weighing up to 4,000 pounds. Sometimes the automatic striking machinery was incorporated into the tower or lighthouse and occasionally in a separate bell house. At first some of the bell houses were constructed to jut out over a cliff, allowing the weight to descend beneath the structure. However,

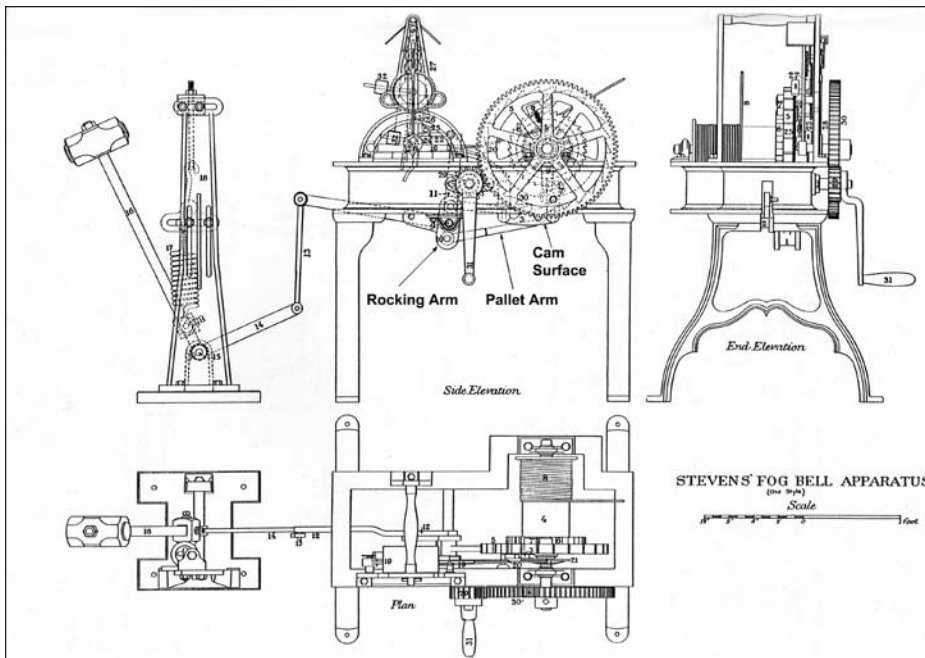

One bell striker that did fail does provide an interesting story. Mrs. Juliet Nichols was the keeper of the Point Knox Lighthouse on Angel Island in San Francisco Bay from 1902 to 1914. She was the widow of Commander Nichols, USN who had been the inspector of the California District (1892 to 1895). He died during the Spanish-American War, and she was later offered the keeper's position.

On July 2, 1906, the fog rolled into the Bay and Mrs. Nichols dutifully set the fog bell striking machinery in motion...and it failed! She was the sole keeper of the station and had no way to contact the district or anyone for assistance. She knew the importance of the bell to the ferries that passed Point Knox en route to Sausalito. Being a dedicated keeper, she took an ordinary nail hammer and began ringing the bell by hand. The characteristic was two blows every 15

seconds. The fog stayed and Juliet remained at her post; for 20 hours and 22 minutes she rang the bell by hand. She was presented a service award for her feat and appeared as a heroine in several publications, including the *National Geographic* magazine. Although her station has been razed, the 4,000-pound bell, with hammer marks clearly visible, remains at the site.

While rather eccentric in appearance, they were, by and large, rather reliable, and bell strikers lasted well into the 20th century.

Experiments with bells proved that the rapidity of the bell strokes was related to the distances that a bell signal could be heard: 15, 25, and 60 strokes a minute were in ratio to 1, 1.14, and 1.29 miles.

Several countries experimented with bells (as well as other signals) in the mid-19th century. Mr. Cunningham, of the Scottish lighthouse service, stated that the 2¼ ton bell at Howth, struck four times a minute by a 60-pound hammer, could be heard only one mile to windward against a light breeze during fog. He also reflected that he doubted if the bells at the Bell Rock and Skerryvore lighthouses were ever responsible for saving a single vessel from wreck during fog and does not recall an instance of a vessel reporting that she was warned and put about in fog or ascertained her position because of either bell signal. General Duane, U.S. Army, said "a bell...cannot be considered an efficient fog signal on the sea coast. In calm weather it cannot be heard half the time at a distance greater than one mile, while in rough water the noise of the surf will drown its sound to seaward altogether." The French placed a hemispherical iron reflector behind bell signals in an effort to increase the distance.

Over the years bells have been required on ships by international code to be rung at regular intervals during period of fog. But, interestingly, Turkish ships are allowed to substitute a gong or a gun, as the use of bells is forbidden to the followers of Mohammed.

Celadon Daboll, of New London, Connecticut, also developed the first practical power-operated fog signal other than bells. Responding to an announcement of the newly elected U.S. Lighthouse Board, he developed a compressed air fog trumpet. He powered his signal by horse power or by hand. Daboll made two designs for his horse-powered signal: one had a horse walking a ramp that



Juliet Nichols' fog signal station on Angel Island in San Francisco Bay. The 4,000-pound bell is located in the shadows of the bell house. USLHS archive photo.

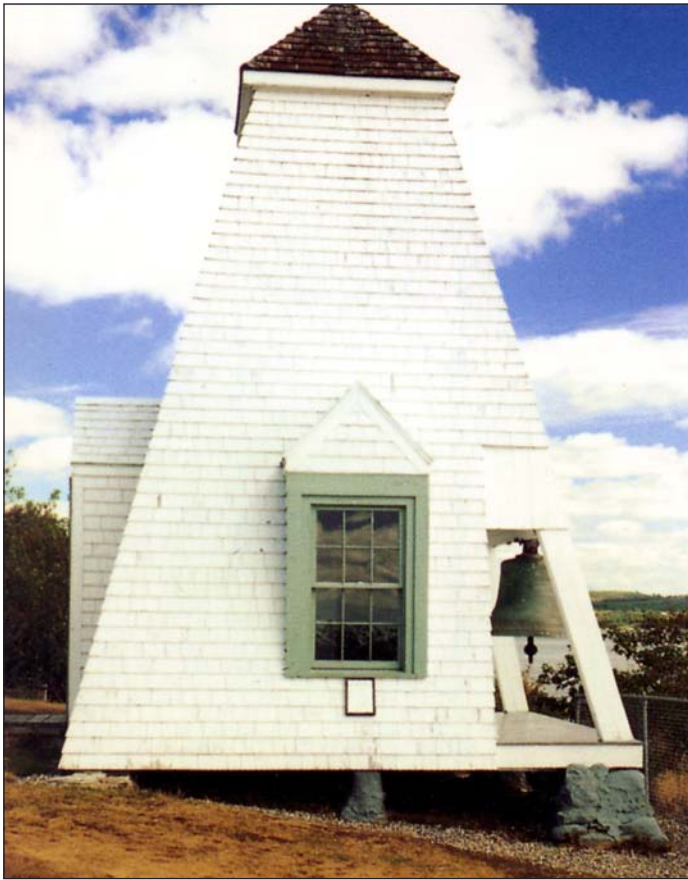

Some bell houses incorporated the weights within the structure, like the bell signal house at Fort Point, Maine (above). Others, like the Pemaquid Point, Maine, structure (below), had towers separate from the bell house. USLHS archive photos.



compressed or pumped air into a holding tank; the other design required the horse to walk in circles, around the tank. Air could also be pumped into the tanks by hand. His first signal was placed aboard the BARTLETT REEF Lightship off New London, Connecticut, and, not being practical for horses, was powered manually. When enough air pressure was present in the air tank, a valve was released and the air passed through a locomotive whistle or reed trumpet. The trumpet was similar in principle to a vibrating clarinet reed. However, the trumpet reed was steel, 10 inches long, $2\frac{3}{4}$

inches wide, and tapered in thickness from one inch at the fixed end to $\frac{1}{2}$ inch at the free end. The signal proved successful, and in 1851 a horse-powered signal was installed at the Beavertail, Rhode Island, Lighthouse as an experiment. Daboll apparently established the signal at his cost, hoping for eventual approval and payment from the government.

Prior to this, an act of Congress in September 1850 provided \$2,500 for establishing fog signals at lighthouses at Execution Rocks and Little Gull Island in New York and Beavertail in Rhode Island and aboard the BARTLETT REEF Lightship. But before any funds were spent, the secretary of the treasury, Thomas Corwin, instructed the Lighthouse Board to investigate the new signal at Beavertail.

W.B. Shubrick, president of the new Lighthouse Board, reported to the secretary of the treasury:

Sir: The lighthouse board specially instructed by the department have visited the Beaver-tail light-house and examined the fog whistle of Mr. Daboll.

The board had favorable opportunity to witness and judge of the power of the whistle in passing up the sound, on the morning of the 29th ultimo. They left New York on the evening of the 29th, in the steamer *Empire City*; the early part of the night was clear, but as the steamer approached the east end of Long Island and the passage between Beaver-tail and Brenton's Reef, the fog became so dense that navigation would have become extremely hazardous without some better guide than the compass and the lead, and this was found in the whistle, which sent its clear and shrill notes far over the water, indicating the bearing of the point on which it is placed, much more accurately than a bell or gun would have done, and enabling the steamer to arrive, with little loss of time, at her port.

The board recommended the expenditure of the appropriations made by Congress for the purpose of placing the whistle at other points contemplated, and are of the opinion that the substitution of horse-power for hand power, is very desirable in all cases which will admit it.

Daboll wrote a letter to the secretary of the treasury stating he could construct the signals at the three lighthouses and one lightship for the amount appropriated by Congress and remarked, "The horse-power machine now at Beavertail will not cost more to work, per annum, than hand-power, or what is paid for ringing or tending fog bells, and it has advantages over manual labor, and will at all times insure a greater and more uniform pressure—being heard, as will be proved by vouchers, from two and a half to ten miles."

However, the captain of a Revenue Service cutter, Green Waldren, disagreed with the horse-power statement of Daboll. Waldren was sent by Treasury to check out the signal. He stated, "The machinery (of the fog signal) is exceedingly simple, being destitute of complication, is easily understood, even by the most illiterate...I would most respectfully recommend Daboll's fog horn, to be worked by hand. This would give the navigator a better opportunity to determine his position between [Little] Gull Island and the light-ship at Bartlett's Reef in thick weather." One wonders how the navigator can distinguish between a horse-operated machine and one operated by humans.

Asked their opinion, several mariners (the collector of customs at Newport and others) all responded favorably to Daboll's new signal. Many stated that they could hear it in excess of six miles (over sea and

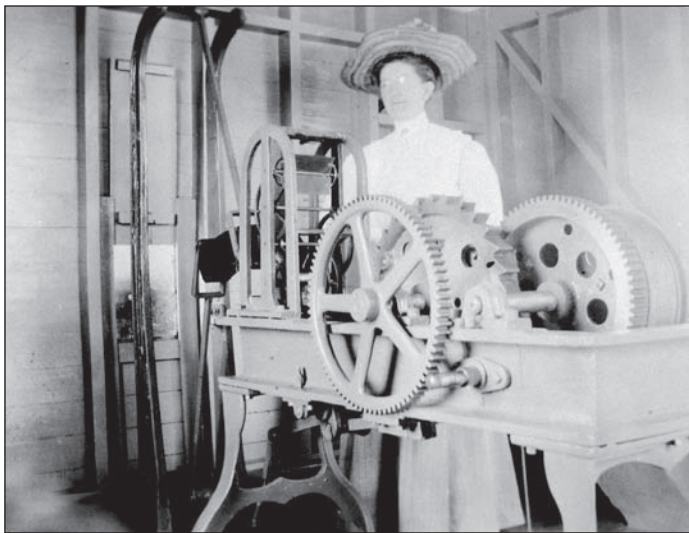

The keeper's wife with a large model of the Daboll bell striker. The hammer can be seen at left next to a slot in the wall which allows it to reach the bell. USLHS archive photo.

land). "I often hear it when about the streets [of Newport, some six miles away], even if there is considerable noise of carriages, etc."

The Beavertail station eventually played a major role in fog signal experiments over the years. Other stations received the signal and the fact was noted in the 1852 *Light List*, when bells and trumpets were listed as aids to navigation for the first time. While the signal was successful, it wasn't entirely satisfactory. Although the sound was more penetrating than that of a bell, the expense and inconvenience of the maintenance of the horse prevented its extensive use. But the invention of the caloric steam engine gave Daboll's signal new life and widespread use.

The most successful caloric engine was invented by John Ericsson of *Monitor* fame. It was first made public in 1833 and was given a name to distinguish it from earlier, not so successful, hot-air engines. The engine had a piston-like canister driven up and down by the expansion

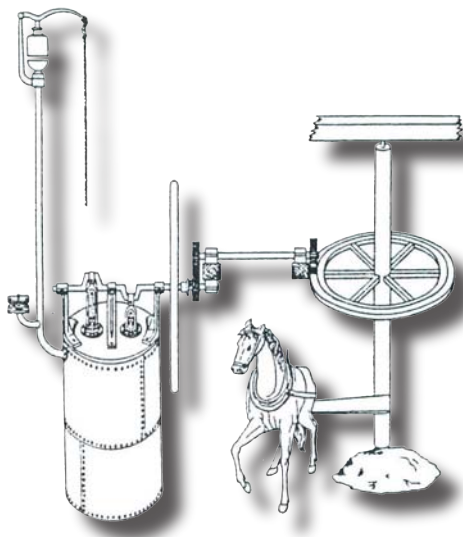

Horse-powered fog signal. USLHS archive image.

of air heated by a coal fire or gas flame. The engine improved the lot of air signals, but eventually they were replaced by steam fog signals, the steam boiler being far more efficient than the caloric engine.

Steam-powered whistles were investigated in 1855, with a 5-inch ship's whistle being installed at the Beavertail, Rhode Island, Lighthouse in 1857. This signal was subsequently replaced by a reed horn signal powered by the caloric engine in 1866. The 1850s and 60s was an age of intense experimentation for the Lighthouse Service. The newly appointed U.S. Lighthouse Board was busy trying to improve the aids to navigation of this country which had lagged far behind most European countries for a number of years.

In the 1867 report of the Lighthouse Board the service reports, "Complaints have been made in this [1st District] and other districts as to fog signals, and these are not without foundation. The subject, however, is one of much complexity, involving, as it does, not only great mechanical difficulties, but also sectional prejudices, and personal interests as to the kind of instrument to be employed." The report stated that at certain locations more powerful signals were needed, bells and guns had been proven ineffective, and that



Beavertail Lighthouse was the site of many early fog signal experiments. In this photo the fog signal building, at right, has a whistle signal (in duplicate) installed. USLHS archive photo.

the year before a trumpet operated by heated air was inefficient. The report stated, "It is probable that, to supply the requisite motive power to produce more efficient signals, recourse must be had to the use of steam. The board have, however, hesitated to introduce this power, not only on account of the expense of fuel and attendance, but also on that of the danger of intrusting the management of an agent of so much explosive energy to ordinary light-house keepers." The board did note that safety improvements had recently been made to steam boilers in recent years and that they would conduct experiments as to suitability.

The first stations regularly equipped with steam whistles were West Quoddy Head and Cape Elizabeth, Maine, when they officially went operational in 1869. They employed a 10-inch locomotive



A keeper polishes a first-class (12-inch) whistle, circa 1930. USLHS archive photo.

or ship's whistle. This was the most powerful signal up to this time. European nations shunned use of a locomotive whistle as a signal as it closely resembled a ship's whistle. It was felt that a vessel, in reduced visibility, would think it was encountering another vessel. When vessels "talk" to one another, one blast means "let's pass port side to port side (left to left)." A vessel "hearing" a lighthouse fog signal might think he was being asked to come to port or starboard and, depending on his location, this could have disastrous results.

One story, unsubstantiated, concerns a German ship that departed San Francisco Bay around 1910 and headed south along the coast. The ship entered heavy fog and began sounding her signal. Around Pigeon Point, the captain heard a ship's whistle sounding two blasts, which "requests" a starboard-to-starboard (or right-side-to-right-side) passage. The German ship came left (to port) and ran aground at Pigeon Point. The two whistle blasts came from the Pigeon Point Lighthouse fog signal. Pretty soon there were 150 German sailors knocking on the keeper's door in the early morning hours.

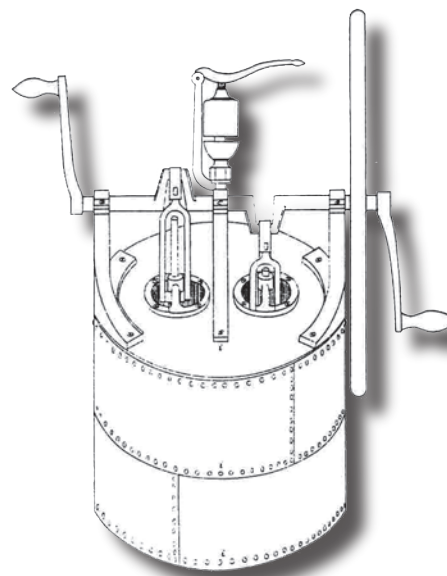

The hand (keeper) powered version of Daboll's air whistle was probably not as popular with the keepers as the horse-powered version. USLHS archive image.

Mariners were no doubt confused by lighthouse whistles in the fog on a few occasions, but whistle fog signals continued to be used at lighthouses throughout the United States for many years.

Another sound signal that arose from this period of experimentation was the siren. It was first tested in 1867 and installed at the Sandy Hook East Beacon in 1868. Originally this signal consisted of a large cast-iron trumpet. In the mouthpiece of the trumpet, a slotted, revolving disc, or plate, was placed on a fixed slotted disc (seat). A slotted disc valve was placed on the back of the seated disc, which produced the characteristic. The chamber containing the discs was directly affixed to the steam dome of the boiler. About 70 pounds of steam was forced through the fixed and rotating discs and the interruptions of the jets of steam produced the note. Eventually the disc type of siren was replaced by a rotating cylinder with peripheral slots (called the rotor) placed inside a casing, also with slots (termed the stator).

One reporter, after hearing a siren for the first time, described it as having "a screech like an army of panthers, weird and prolonged, gradually lowering in note until after half a minute it becomes the roar of a thousand mad bulls, with intermediate voices suggestive of the wail of a lost soul, the moan of a bottomless pit and the groan of a disabled elevator." Not exactly conducive to lulling a light sleeper to dream land.



The siren rotator is pictured above at left. USLHS archive photo.

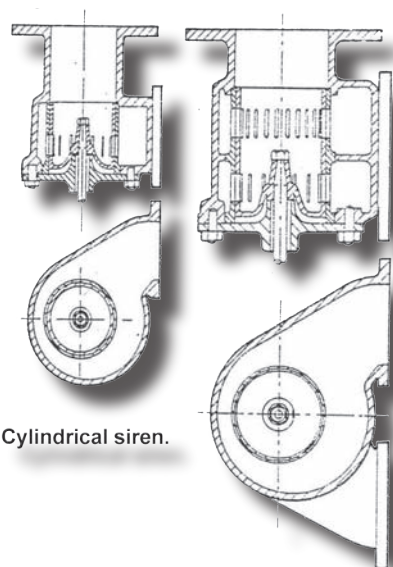

Cylindrical siren.

Two-tone cylindrical siren.

By 1870 the trumpet, whistle, bell, and siren were perfected, and all were standard fog signals. Because the bell had poor resonance and carrying power, it was not effective at coastal locations where wind would dampen the signal. Coastal stations received the steam whistle or siren, the reed horn trumpet was installed at less exposed locations, and bells in bays, estuaries, and along rivers. Most Chesapeake Bay lighthouses had a bell signal incorporated into

the combination keeper's quarters-light towers (generally the bells ranged in weight from 1,200 to 4,000 pounds).

In the early 1870s, the service conducted extensive experiments with different types of fog signals at New Haven, Connecticut; Sandy Hook, New Jersey; Boston, Portland, and other stations. In 1874 Joseph Henry, then chairman of the Lighthouse Board, wrote a report concerning the tests. He began by stating, "Among the impediments to navigation none are perhaps more to be dreaded than those which arise from fogs, and consequently the nature of this impediment and the means which may be devised for obviating it are objects of great interest to the mariner."

The tests involved a double whistle (or steam gong), factory whistle, locomotive whistle, siren, trumpet, bell, and comparisons between different powering apparatus of same-type signals. The tests were conducted on sail and motor vessels. The tests indicated that the siren was the most penetrating. The top three signals were assigned relative power: first-class siren – 9, 12-inch locomotive whistle – 7, and first-class Daboll trumpet – 4. But other factors also came into play. Consumption of fuel and water: the siren consumed about 180 pounds of coal and 126 gallons of water an hour, the 12-inch whistle 60 pounds of coal and 40 gallons of water an hour, and the Daboll trumpet only 20 pounds of coal an hour. Relative expenditure of fuel was the siren 9, whistle 3, and trumpet 1.

He also noted that the siren was the most complicated of the three devices with many moving parts, a high velocity of rotation (1,800 – 2,400 rpm), and developed a large quantity of steam which could be dangerous. "The constant attention of the keeper is required to regulate the fire, the supply of water to the boiler, of oil to the journals, etc." he said.

Of the Daboll trumpet (powered by a caloric engine) he stated, "...requires little fuel, no water and is perfectly safe as regards danger from explosion, it would at first glance, appear to be the most suitable power that could be applied to fog signals...It was, however, found to be so liable to accident and so difficult to repair that of late years it has almost been entirely rejected."

Of the steam whistle, he found that it required much less steam than the siren, less pressure, the machinery was simple, and that the signal may be operated by hand should the engine become disabled.

"It will thus," he said, "be seen that the siren is the most expensive of the fog signals as regards maintenance, and that it is adapted only to such stations as are abundantly supplied with water and situated in the vicinity of machine shops where necessary repairs can be promptly made." He went on to state that there are important locations where the loudest possible signal (siren) must be employed whatever the drawbacks. And in those cases the stations should be supplied with sirens in duplicate, with ample spare parts, and even a keeper who is a licensed engineer.

The investigation tested locomotive whistles from 2½ inches diameter to 18 inches in diameter. Although the larger whistles were slightly more powerful, the increased energy necessary to power them was not worth the cost for so little gain in strength. Thus the service settled on 10-inch and 12-inch whistles as standards.

In 1878 there were 55 fog signals operated by steam or hot air and 93 bells sounded by automatic bell strikers. That year, in their annual plea for more funds, the board reported, "The failure of a single important fog signal to give forth its warning notes at the proper time may lead to the loss of property sufficient to keep all in the United States in repair for years, to say nothing of the possible loss of life. The mariner in the fog depends almost as much

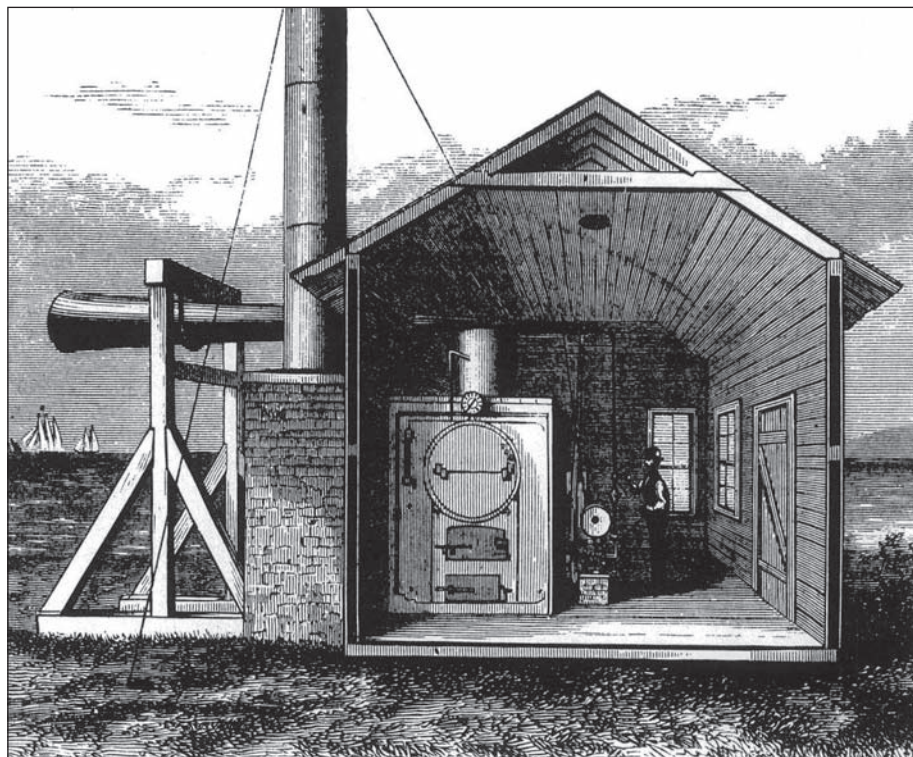

The first steam-powered siren was installed at Sandy Hook, New Jersey, and no doubt resembled this woodcut illustration from a *Harper Weekly*. USLHS archive image.

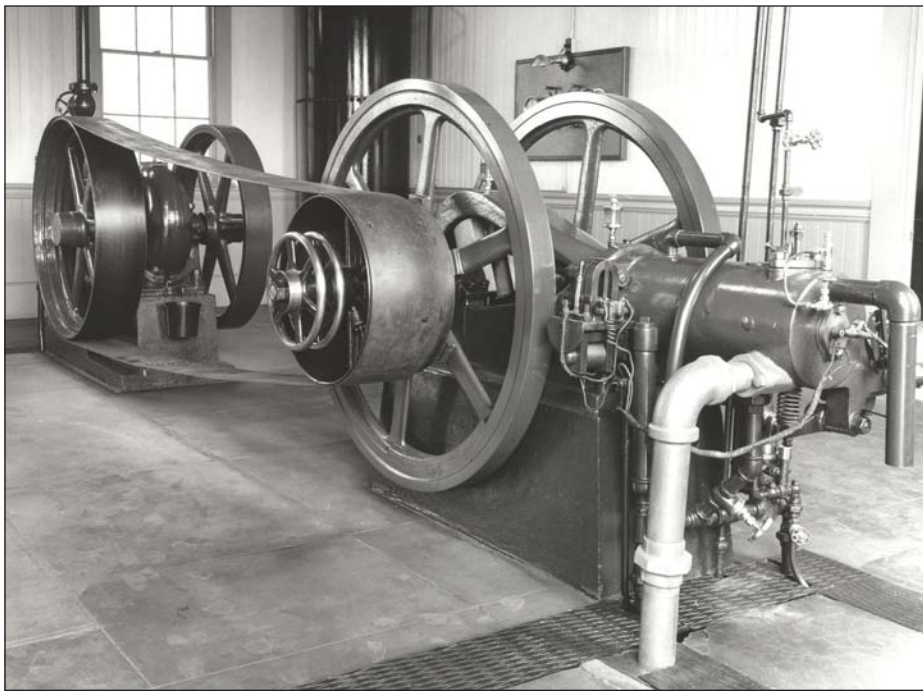

The Hornsby-Akroyd oil engine was a popular replacement to the coal-fired boilers. The engine belt above is linked to an air compressor by a large leather belt. The air tank can be seen behind the closest fly wheel. USLHS archive photo.

on the fog signal as he does in clear weather on the light. To ensure certainty of its being sounded they should be in duplicate at each station, so that in case of an accident to one, an occurrence by no means rare in steam machinery, the other is ready for service.” And, at most stations this did become the norm.

In 1898 the board reported that it was revising plans of the steam siren to update it. “Oil engines have been installed at a number of stations to replace caloric engines. There are now available several excellent forms of the oil engine, and its use for both fog signal and electric light apparatus at stations where questions of water and fuel supply or other reasons render steam machinery objectionable

buildings. The air compressor powered by a diesel engine was far less work and much cleaner than the old method.

By 1900 there were 377 fog signals, exclusive of those on buoys, around the country, with an annual operating cost of \$200,000. Fog signals had become big business.

Around the turn of the 20th century, a Canadian firm developed the well-known and much loved diaphone (Super Typhon) sound signal. It came in several models: as a single tone, two tone (F2T), and chime. However, it wasn't introduced into the United States until 1914. The Lighthouse Service was so taken with this new (beehhh)

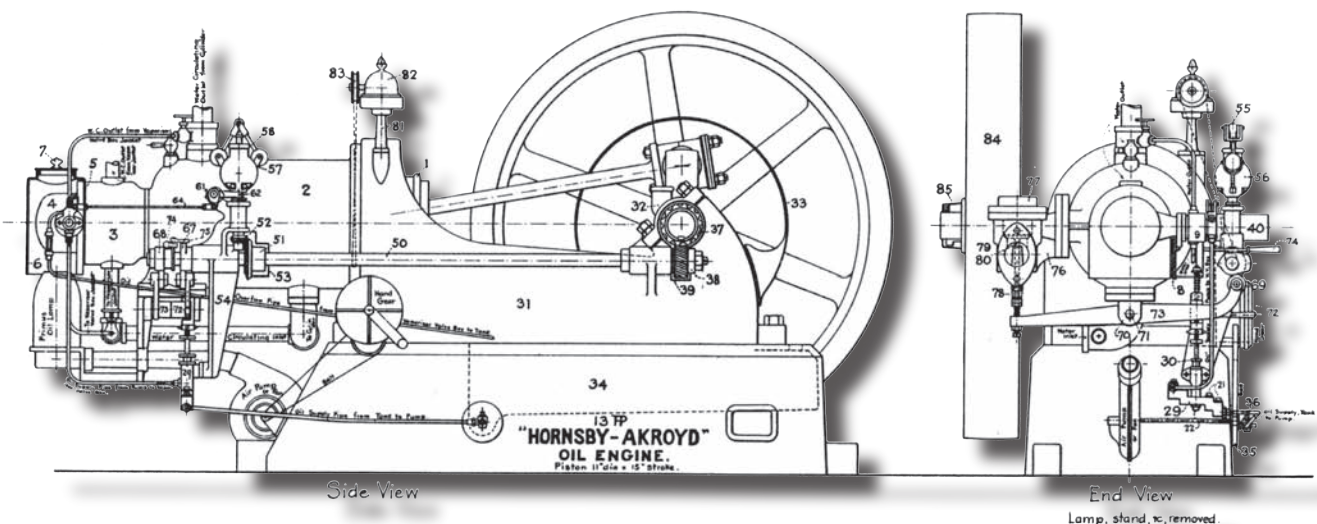

signal that it acquired the drawings, patterns, and rights to manufacture the equipment in this country, which was carried out by a New Jersey firm. Diaphones, with their deep throaty sound, carried as well as any signal developed to that date and was much more “population friendly” than the siren and reed horn. Many foggy areas of the coast were growing by leaps and bounds, and complaints began to arrive at district offices from a population trying to sleep with a siren (“...roar of a thousand mad bulls...”) seemingly in the next room.

Diaphones, though, were difficult and expensive to maintain. Each horn came with three sleeves of brass that vibrated (back and forth) in a chamber of the horn. When one wore out it was replaced with one of the spares especially designed for that horn. When all three were worn out a replacement had to be manufactured requiring a skill not always available.

In 1929 the service developed a diaphragm horn. This horn, sounding somewhat like a diaphone horn, was far less expensive to manufacture and to service. The sound mechanism consists of two metal discs each about $\frac{1}{16}$ inches in thickness. One disc is solid and $5\frac{7}{8}$ inches in diameter and the other $6\frac{3}{4}$ inches in diameter with a 3-inch hole in the middle. The discs are placed together in the horn and as air passes between them the sound is produced. The plates are almost indestructible and the major maintenance of the entire apparatus is a regasketing of the air compressor about every seven years at a cost of less than \$100.

By the 1930s large harbors like New York, Boston, and San Francisco had a vast variety of signals. As an example, San Francisco Bay in 1936 was alive with a cacophony of 51 diaphones, whistles, bells, and sirens all moaning, hooting, screeching, and dinging in a variety of characteristics, each vying for the attention of the mariner.



Diaphone piston. USLHS archive photo.

The Coast Guard took over the Lighthouse Service in 1939, and after WWII began to make sweeping changes in the aids to navigation of this country.

Compressed air strikers were replaced by battery-powered strikers that eventually tore themselves apart. Trumpets were gone by the 1950s and sirens and whistle signals by the late 1960s. Slowly the service phased in new electronic horns and phased out the difficult-to-maintain diaphones (the last were those on lightships) leaving, today, just a few diaphragms and the new electronic pure tone signals in existence.

IALA (International Association of Lighthouse Authorities to which this country is a signatory) has decreed that fog signals are no longer necessary for the needs of navigation, and the Coast Guard is slowly phasing out all fog signals. Those remaining, where fishing fleets or pilot pressure is strong, are a few diaphragms and one of two types of electronic “pure tone” signals. The more powerful are the ELG 300 and 500. These signals emit a beep of 142 decibels.

121 Db is the threshold of pain and every increase of three decibels requires the power to be doubled. Standing one meter from an ELG 300 signal will rupture ear drums. The smaller signal is termed an FA 232. Its electronic beep can be made to sound like a horn (of sorts) or a bell. The signal is rated at one mile. Both signals are extremely disturbing to a sleeping population, and the Coast Guard has been required to discontinue them when their sound encroaches into residential areas.

In fact, the small signal really isn’t of much value. It’s almost impossible to hear on the bridge of any large vessel or against the wind on any size vessel. The large signal can be heard at four miles under the right atmospheric conditions but cannot be placed where it would disturb a residential area.

Slowly the Coast Guard is phasing out the few remaining and soothing BOOOOooH signals that echo throaty sounds across bays and harbors and along certain stretches of seacoast. That romantic sound will soon pass over the horizon along with the age of manned lighthouses and the tall ship. And these will soon be followed by the obnoxious “pure tone” horn, a signal that is of little value and very annoying. It will be hard to imagine Sam Spade sidling down the Hyde Street hill under haloed street lights in search of the Maltese Falcon, unaccompanied by the mournful bellow of the throaty diaphones oozing their sound through the dripping fog.

Unusual Fog Signals

The 1950 *Atlantic Coast Light List* includes a listing for the West Point LT 19, on the Hudson River, which states (in addition to information about the light) “BELL, electric, 1 stroke every 20 seconds. Operates automatically only by blast of a ship’s whistle.” Keeper Ken Black, of the Shore Village Museum, Rockland, Maine, informed us of this unusually activated signal. As ships approached West Point, they sounded their whistle that automatically activated the bell for a certain duration. From our *Light Lists*, it appears this bell fog signal became operational around 1948 or 1949 and was discontinued in 1965. We have no other information on this signal or if there were others established.

Echo Boards

In certain areas of the country, like California’s Sacramento Delta, the Lighthouse Service established “echo boards,” usually at bends of a channel or junctions of waterways. Ships approaching a bend would sound their whistle and the resultant echo gave the pilot or captain a vague idea of how far he was from the bend or junction, as well as warning any approaching vessel of his presence.



The Junction Point echo board in California’s Sacramento Delta. USLHS archive photo.



Finicky Fog Bells

By Jeremy D'Entremont



When fog bells first came on the scene at American lighthouses in the early 1800s, the keepers had to sound them by hand in time of storms and fog. After a while, things improved with the introduction of automatic striking mechanisms—Rube Goldberg-like contraptions that utilized a clockwork mechanism that had to be wound every few hours.

The introduction of automatic bell-strikers may have been an advancement in technology, but it meant the keepers had more equipment to maintain. And it was not terribly unusual for the machinery to fail, which meant that keepers or family members sometimes had to resort to ringing the bell by hand. This was done by using a hammer or by pulling an attached rope. Lighthouse literature is filled with story after story about superhuman efforts under such circumstances.

Charles Slocum Curtis became keeper at Rose Island Lighthouse, near Newport, Rhode Island, in 1887. Curtis saw plenty of change in his 31 years at the station, includ-

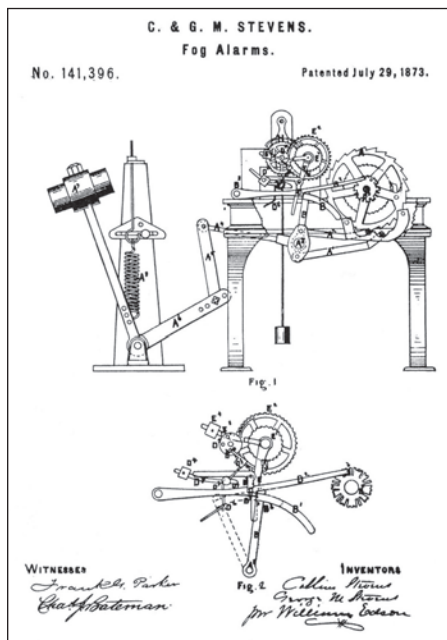

C. and G. M. Stevens' 1873 patent for a fog-bell striker. USLHS archives.

ing the replacement of the fog bell by a new horn. While the bell was still in use, Keeper Curtis and his wife, Christina, had to go ashore one day. They left their daughter, Mabel, alone on the island. Thick fog abruptly rolled in. Young Mabel couldn't get the fog bell mechanism started. She quickly grabbed a hammer and manually rang the bell, approximating its official time sequence for several hours until her parents returned.

One of the better-known female lightkeepers in U.S. history was Juliet Fish Nichols of Point Knox Lighthouse on Angel Island in San Francisco Bay. Juliet grew up with her aunt, Emily Fish, who was the

longtime keeper of California's Point Pinos Lighthouse. Juliet had many battles with the Gamewell mechanism that ran the fog bell at Point Knox. In July 1906, she banged the bell with a hammer every 15 seconds for at least 20 hours. Two years later, the same thing happened again and she hammered away for several hours. Juliet Nichols retired as keeper in 1914, turning over her duties and, presumably, her trusty hammer to Keeper Peter Admiral.

In his 1945 book *Famous Lighthouses of New England*, the popular New England historian Edward Rowe Snow wrote about Keeper Thomas L. Chase at Long Point Lighthouse near Provincetown on Cape Cod, Massachusetts. Today, the Cape Cod Chapter of the American Lighthouse Foundation cares for this lighthouse. Snow wrote that the fog bell mechanism broke down during the last week of May 1933, just before a "pea soup" fog rolled in.

Keeper Chase rigged the bell so he could ring it by tugging on a rope. Using his watch to make sure of the timing, Chase proceeded to pull the rope every 30 seconds, sounding the 1,000-pound bell each time. He kept up the repetitive task from 10:45 p.m. until 8 a.m. the following morning. The fog returned just after dark. The keeper sounded the bell again until 2 a.m., this time using his left hand as he rested his sore right arm.

The next day, Chase rode his makeshift dune buggy into Provincetown and picked up the needed replacement parts. He managed to fix the mechanism before the fog returned. He told a friend, "I feel like a baseball pitcher who has twirled a couple of double-headers without rest," but said that he would have tied the rope to his legs if necessary. If it was foggy, the bell would be sounded—period.

It's said that Fannie May Salter, who became keeper at Maryland's Turkey Point Lighthouse in 1925, once saved a large steamer from going aground in the fog by striking the bell with a hammer every 15 seconds for nearly an hour. While she was



Left: The fog bell at Rose Island Lighthouse sits in a wooden frame. USLHS archive photo.



Long Point (Massachusetts) Lighthouse and bell tower. USLHS archive photo.

occupied with this unusual duty, Keeper Salter missed a phone call from her son-in-law that would have informed her that her new granddaughter had just been born. Because winding the striking mechanism was strenuous, in 1928 a laborer was hired at \$25 per month to wind the machine for Fannie May Salter.

This barely scratches the surface of the tales of keepers going above and beyond when fog signal machinery failed. Hammer or rope in hand, the ever-vigilant keepers proved time and time again they were willing to do whatever it took in service of safe navigation.

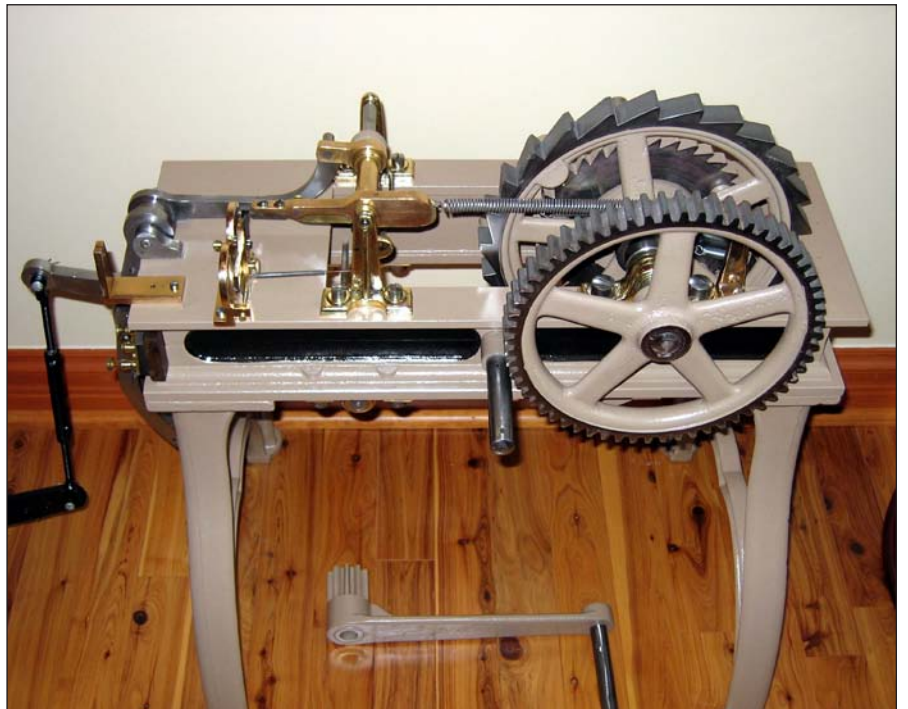

Right: A Gamewell fog-bell striker. USLHS archive photo.

The Light from the Whale

By Mike Vogel



Early in the 19th century, Charles W. Morgan—the man, not the National Historic Landmark whale-ship—sent a shipment of sperm oil on its way from the wharves of New Bedford to the lighthouse in Buffalo. In doing so, he set in motion a chain of transportation links that included the century’s foremost engineering marvel, committed the product of a hazardous sailing occupation to a use for mariner safety, and probably made a little money to use in building his namesake vessel.

Sperm oil—a vastly different substance from the whale oil rendered from blubber—was the primary fuel for lighthouse lamps for decades. Eventually, it was overrun by new technologies. So were square-rigged whaleships. And lighthouses. And the whaling industry.

What remains is the history, the heritage—and a few tangible links to the past. The *Charles W. Morgan*, launched in 1841 and named for its builder and principal owner while he was away on business, still exists, a carefully-tended museum ship at Mystic Seaport. So does the even older 1833 Buffalo Lighthouse that once burned oils brought back by America’s world-leading whaling fleet.

And, this year, the *Charles W. Morgan*—now completely restored—even sailed again, on her 38th voyage. Sailing in her was the keeper of the also-restored Buffalo Lighthouse: me. Funny how life works, sometimes, whether it’s the life of a ship or the life of a person.

The bill of lading Morgan penned at his desk in New Bedford that day, sending barrels of precious oil trundling westward along wagon routes and the new and marvelous Erie Canal, added a drop to a vast river of light-giving fluids that lasted until the petroleum industry began its rise in the middle of the 19th century. Sperm oil, the brightest and cleanest-burning fuel available, was the illuminant of choice for the U.S. Light-House Establishment until cheaper post-Civil War replacements were found in vegetable and mineral oils: colza or rapeseed, lard oil, and kerosene.

In the early days, merchants such as Morgan dealt directly with the country’s lighthouse districts and depots, including the one in Buffalo, the western terminus of the Erie Canal and the key portal between the Atlantic Coast and the heartlands of the Great Lakes. Even with the canal, that journey took days. Buffalo-based office superintendent and inspector of lights Henry B. Miller, in an 1851 letter to Stephen Pleasanton who headed the lighthouse service from his office at the Treasury Department in Washington, noted that Samuel Grinnell of New Bedford had informed him that the oil for the “northwestern lakes” had shipped from that port on April 26 and that “it usually takes from four to six days to make the passage from New Bedford to Albany, and from eight to ten from Albany to Buffalo, so we can safely calculate on the oil being here by the 15th of May.”

That would be fine for Buffalo, but Miller urged Pleasanton—the man who, by the way, saved the Declaration of Independence and the Constitution as the British approached to burn Washington in the War of 1812—to instruct the collector of the Port of Buffalo to have a vessel chartered and ready to sail on that date for the rest of the Lakes’ lighthouses.

From 1867 to 1869, though, the Light-House Establishment burrowed a series of large vaults into the hillside behind its new



Charles W. Morgan. Courtesy of Mystic Seaport.

General Light-House Depot on Staten Island and began processing all the sperm oil, lard oil, and eventually mineral oil for its lighthouses through that gateway site. The move centralized control of the oil procurement process, it let the penny-pinching bureaucrats of the service dole out amounts calculated from the specified usage rates of the lamps and lens arrangements at each lighthouse in a given district, and it allowed for a laboratory to test the quality of the oil being purchased from merchants for use in lighthouse lamps.

The volume of the oil trade was considerable; the depot had five 51-foot-deep vaults and a sixth half-size one, with arched ceilings 13 feet high. Each of the vaults—they, too, still survive—had large iron storage casks lined with tin, and long barrel storage platforms with iron drip



Facing page: The whaler *Charles W. Morgan*.
Right: The name plate. Photos by the author.

trays. Together, they allowed for the safe storage of 85,000 gallons of oil, 35,000 of that in the rows of barrels ready for shipment.

In the years sperm oil remained the illuminant of choice, that amount of oil would have been an expensive proposition. It would, in fact, become the biggest cost in lighthouse operation.

By the middle of the 19th century, fewer sperm whales were being taken and industrial uses of the oil as a lubricant were increasing, sending prices up. The oil had brought about 55 cents a gallon in the year the *Charles*

W. Morgan was launched; sperm oil production peaked in 1846, but by 1855 it was scarcer and fetching \$2.25 a gallon. At the average price for sperm oil when the vaults were built—and had they been used to store only sperm oil and not also the lard oil then coming into use—the vaults could have stored nearly \$110,000 worth of the fluid. That's in post-Civil War dollars, the equivalent of about \$1,800,000 today. The equivalent amount in 1855 would have been about \$4,713,000. In that year the principal keeper of the Buffalo Light, James Anderson, made an annual salary of \$400—the equivalent of only about 178 gallons of sperm oil.

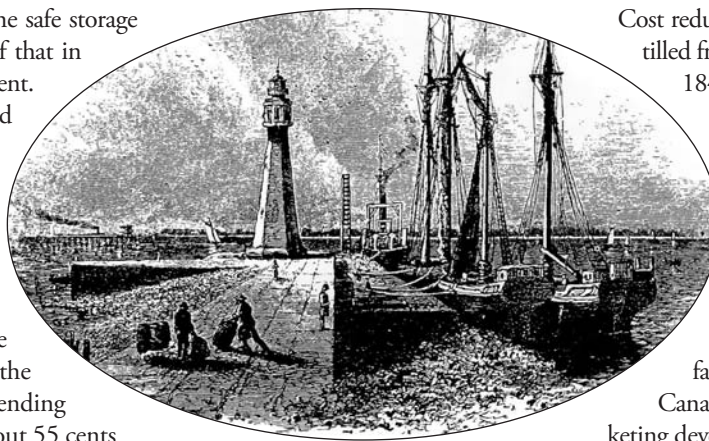

Artist's rendering of ships off-loading supplies at the Buffalo harbor. USLHS archive image.

Cost reduction seemed crucial. Kerosene, distilled from petroleum, had been invented in 1849, but in the mid-1850s the Light-House Board first followed the French interest in colza or rapeseed oil from varieties of *Brassica rapa*, a turnip-like wild plant abundant in Europe that offered a less efficient but far cheaper alternative to sperm oil. The rapeseed crop didn't catch on with American farmers—at least until 20th century Canadian scientists with an eye for marketing developed a tastier low-acid version they patriotically named Canola oil—so Light-House Board experiments headed by professor Joseph Henry of the Smithsonian shifted instead to lard oil.

By 1867 preheated lard oil was ready for use in the larger lighthouse lamps, and sperm oil use went into decline. Kerosene, experimented on by the board in the 1870s, would begin replacing lard oil in turn, reaching usage in the lamps of larger lenses in 1884.

Sperm oil had a long run, though, from the changeover from spermaceti candles in colonial lighthouses to the time of the Civil War. Because America dominated the whaling industry, American lighthouses stayed with the oil much longer than the lighthouse establishments in



Lithograph, "Sperm Whaling #1 - The Chase," published by Endicott & Co., New York, from drawings by A. Van Beest and R.S. Gifford, corrected by Benj. Russell, Esq. 1859. Courtesy of Mystic Seaport.



The main deck of the *Charles W. Morgan* at night. Photo by the author.

France and Europe. And the journey from whale to lamp passed first through the holds of ships like the *Charles W. Morgan*, which could spend years at sea to fill its hold with casks of oil and spermaceti.

They were years of discomfort and hardship, with hours of dangerous action and days of hard work mixed into long periods of boredom and searching. The oil that burned in the lamps of American lighthouses came from that hardship, one hunted whale at a time.

This summer brought a short taste of that life, although in much different circumstances. Aboard the *Charles W. Morgan* for a day-long passage through Boston Harbor, Massachusetts, and Cape Cod Bay and the Cape Cod Canal, I found a cramped berth just beside the foremast in a foc's'le made hot and humid by a day of blazing August sunshine. The tiny space "before the mast" housed 24 of us, all equally hot and humid, with little room to move in and out or even to shift position in the shelf-life berths; while the men sweated, one of the southern women in our crew (now there was a difference from the days of a working whaleship!) insisted that the women would not, but allowed that they might perhaps "glisten."

Few drew the privacy curtains on the berths; some discovered that a shelf along the curve of the hull offered a tiny bit more space and a wall cooled by the sea outside. Under sail, full-voyage chronicler Ryan Leighton offered, there was also the comforting *swash* of the sea against the planks of the bow. This night, there would be only the scream of an able seaman awakened by a nightmare that caused him to kick the wall of the bunk next to his.

About 2 a.m.—four bells in the middle watch—a breeze came up. The sailcloth chute rigged to channel air down a companionway into the foc's'le lifted with it, sliding up a few rungs and alerting me to the possibilities. I slipped out, climbed to the deck, and had the cool breeze and ship—and the USS *Constitution*, docked just ahead—to

myself for a while. The shadows and the wind whispering softly in the rigging took me back in time.

The heat and humidity would have been much the same back in the day, except when the whaleship left the South Pacific for the sharp cold of the Arctic grounds. But the living would have been made immeasurably worse, at least as long as the olfactory nerves survived, by the fact that the crew's living quarters in the bow were just ahead of the "blubber room," the 'tween-decks processing center into which long strips of whale were lowered for cutting and storage. In close confined quarters, and with the fires of the blubber-melting try-works just above, the smell of the sea and its creatures must have been almost overpowering.

The *Charles W. Morgan* would have processed and packed thousands of barrels of whale products each voyage. One large sperm whale alone could yield about 500 gallons of spermaceti. The ship's voyages covered thousands of miles in passages to the whaling grounds, and in the hunt.

One of the surprises in bringing this ship back to life was the quality of that sailing. The last of its kind, and the oldest merchant vessel in the world, the *Charles W. Morgan* essentially was a factory ship, but, as I would learn during a turn at the helm off the Gurnet Lighthouse, a surprisingly nimble one.

Charles W. Morgan was my fifth square-rigger under sail, and each has its own personality. Neither quite as solid as USCGC *Eagle* nor as elegant as the Norwegian Sail Training Vessel *Christian Radich*, she nonetheless answers to the helm quickly—maybe a little too quickly, until I got the hang of her combination tiller and wheel steering rig—and responds well to the wind.

She did eight knots on the approaches to her old home port of New Bedford, Second Mate Sean Bercaw noted as the crew spread sailcloth to the freshening breeze.

She sails, Capt. Kip Files said, "a lot better than anybody expected. People look at the blunt bow, but that's not everything. I just looked at the hull, I knew she could sail."

Whaleships like the *Charles W. Morgan* sailed all over the world's oceans, from the edges of the northern icepacks to the heat of the South Pacific. The rapid spread of American whaling dates to the 1760s and 1770s, with ships returning an estimated 45,000 barrels of oil a year from 1770 to 1775, and the impact on lighthouses was early. Spermaceti candles, made since the 1750s, were used in the earliest chandelier arrangements of reflectors and lights. The definition of candlepower is the light emitted by one standard spermaceti candle, a measure still loosely linked to the candela and lumen.

But in the early 1780s, Swiss physicist Ami Argand developed a lamp that worked best with whale oil, boosting whaling while providing a new source of light for homes, European trains, and, eventually, lighthouses. Winslow Lewis, an American ship captain and entrepreneur who would corner the market on early American

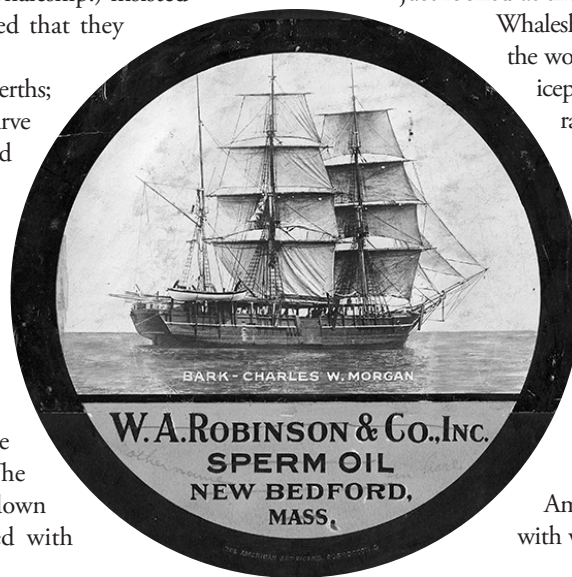

Starboard view of whaling bark *Charles W. Morgan* under sail. Photo used as mock-up for calendar or advertisement display. Printed below vessel is "BARK-CHARLES W. MORGAN." Courtesy of Mystic Seaport.



Above left: Photograph of cutting in a sperm whale on board the whaling bark *California*, probably off the coast of Japan. Image shows men on cutting stage, severing jaw of sperm whale and the lower jaw being hoisted to deck. Handwritten in lower left negative, "Copyright, 1903./ H.S. Hutchinson & Co."; lower right, "3."

Above right: Photograph of cutting in a sperm whale on the whaling bark *California*. Image shows men on cutting in stage over the whale. Handwritten in lower left, "Copyright, 1903/ H.S. Hutchinson & Co."; lower right, "8." Both photos courtesy of Mystic Seaport.

lighthouse construction and equipage, took the Argand burner and patented his version in 1810, promising to use only half the oil of earlier lamps at a time when the government was looking to cut costs by limiting consumption. His friend Pleasanton, who as fifth auditor of the Treasury ran the country's lighthouse service, took special notice of an opportunity for even better and brighter lights in the 1820s, when the expanding American whaling industry opened the "offshore grounds" of the Pacific and found itself with a glut of sperm oil that drove prices down. Pleasanton always had an eye for a cost-savings, sometimes to a fault; later, he and Lewis would delay converting lighthouses from the old chandeliers to the new Fresnel lens, even though it offered 3.4 times the light for the same amount of oil.

Sperm oil and whale oil are very different. Whale oil, generally, is rendered by boiling down blubber taken from such species as the bowfin and the right whale—named because it was the "right" whale to hunt for an abundant return. Spermaceti is taken from the head cavities of the sperm whale, although some poorer-quality sperm oil can be rendered from that species' blubber as well.

Whale oil is basically a triglyceride, which made it eventually useful in such products as margarine. But it was first a fuel, burning easily but dirty, and producing both a relatively poor light and a distinct fishy odor. If you were poor, it was affordable light.

Sperm oil is basically a wax, with varying percentages of wax esters depending on the age of the whale. It comes from the sperm whale's large head cavity, the "case," where it probably functioned mainly to aid in the whale's echolocation, and in the lower head cavities known as the "junk." It was a prime lubricant from the dawn of the machine age to the dawn of the aerospace industry, because it wouldn't break down in extreme conditions. It was used, until relatively recent whaling and whale product bans, in cosmetics, in automatic transmission fluid and as a watch lubricant, and it was the

oleum in the original formulation of Rust-Oleum. It was more expensive, but it burned with a bright smokeless flame, better than tallow or beeswax, that had very little odor. Sperm oil was the illuminant of choice in high-income homes and, because the lighthouse service needed maximum brilliance and minimum soot for its critically important ship-guiding lights, in America's lighthouses.

And Pleasanton, in 1831, could get it for 31 cents a half-gallon. By 1843 that would go up to 63 cents; one ship reported getting \$1.25 a gallon for sperm, but only 43 cents a gallon for whale oil. The average price of sperm oil was \$1.77 a gallon from 1845 to 1855, but it was rising as demand increased and whales declined; in 1854 it was \$1.92 a half-gallon, prompting the Lighthouse Board to search for an alternative, and in 1866 when the conversion to lard oil was looming, it was still \$1.28 a half-gallon.

Eventually the bottom would fall out and by 1896 sperm oil was 40 cents a gallon with replacement petroleum priced at only 7 cents. In the commodity's prime, though, the crew of a ship such as the *Charles W. Morgan* would delight in a successful hunt for a sperm whale.

Hauled alongside, the carcass would be secured and the head cavities would be cut open and bailed out. If the temperature was moderate, the straw-colored spermaceti would start to congeal into a white waxy substance when it hit the air; it could be reheated in the try pots to reliquify it, and the liquids would be quickly packed in casks for processing ashore. Between the head cavities and the blubber, an average sperm whale might yield 45 to 50 barrels of oil, and a large whale might yield 100 barrels. Most of the oil was rendered from the blubber, with the head cases yielding 6 to 8 barrels, although one ship reported 10 from a large bull. The blubber oil had only about 66% wax esters compared to the 71% to 94% in the spermaceti from the head case of an adult; clandestine mixing was not unknown, and Pleasanton made sure his lighthouse service quality control tried to stay on top of that.

In 1853 the *Charles W. Morgan* would return from its fourth voyage to the Arctic, South Pacific, and Sea of Japan with 268 barrels of

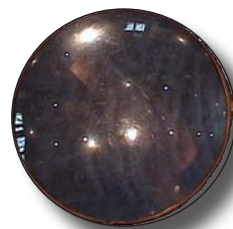

Above: An Argand lens. USLHS archive photo.

Right: A clear glass lamp made for burning whale oil. The top of the blown glass is in the shape of a modern lightbulb. The lamp has two wicks. There is about one tablespoon of yellowish liquid in front, presumably oil. Courtesy of Mystic Seaport.

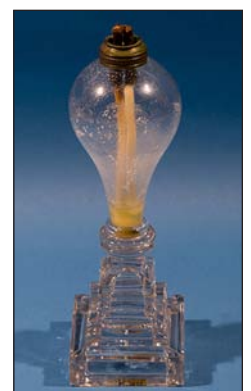



Scrimshaw tooth, decorated on one side only with whaling bark and two whaleboats attacking a sperm whale. On the biting end of the tooth, in Old English script: "The Tooth of a Sperm Whale captured by Captain McCarty in the barque 'Adventure' Aug. 10th 1852 in Latitude 39 degrees 00' North Longitude 38 degrees 42' West - made 90 barrels." Unusually large and fine specimen. Courtesy of Mystic Seaport.

sperm oil at 30 to 35 gallons per barrel, 1,958 barrels of right whale oil, and six tons of whalebone, actually whale baleen that was sought for corset stays, buggy whips, and umbrella frames (10,700 pounds had been shipped home mid-voyage from Hawaii).

In 1859, the year former owner Charles W. Morgan died, the ship left on its sixth voyage to the same grounds, twice landing both oil and bone in Hawaii mid-voyage before returning to New Bedford in 1863, three years and seven months out. The crew had processed thousands of barrels of oil. The Civil War had doubled the prices of whalebone and right whale oil, and the ship landed its most valuable cargo ever, worth a bit more than \$165,407.

That value could be changed a bit by subsequent onshore processing. Whale oil simply shipped, but there was more profit to be squeezed—literally—from the smaller amounts of spermaceti.

Casks of spermaceti were stored and allowed to freeze in the New England winter. Once frozen, the waxy substance was scooped into sacks and pressed; the oil that seeped out was the most valuable of all, the sperm oil that stayed liquid even in freezing cold. Partially thawed spermaceti would be pressed again in spring, and the congealed remainder would be pressed yet again in summer before what was left was sold as wax. The process produced winter-strained, spring-strained, and summer-strained grades of sperm oil, in descending order of value.

The Light-House Establishment (which officially became the Light-House Service early in the 20th century, a couple of decades before the hyphen was dropped) used the different grades, calling them simply winter, spring, and summer oil. Winter oil was sent in season to the colder climates, where even it occasionally had to be preheated in a warming stove. Spring oil was listed on some receipts—in 1852 Buffalo Lighthouse Keeper Alexander Ramsdell signed for 126 gallons of winter and 124 gallons of spring oil—but most often the shipments were either winter or summer oil, or both. While some lighthouses, like Buffalo on Lake Erie, simply went dark when ice covered the waters and ships couldn't move, they too needed winter oil that would stay liquid in the lamps early and late in the shipping season.

The transition from living whale to casks of oil started with a lookout's cry from "the hoops" atop a whaleship mast and the lowering away of whaleboats. The oared pursuit, after species of whale that were slow enough to catch and buoyant enough to float when killed, could be short or long but always was dangerous. Modern eyes would be appalled by the slaughter, but in its day whaling was

an important driver of the American economy and an industry that was absolutely vital to an emerging nation whose maritime trades thrust it upon the world stage.

America's whaling fleet was the largest in the world. In the 1840s there were 735 whaleships in the trade. Peak production in sperm oil happened in 1846, and then the petroleum industry began its rise and kerosene lit the way to the future. In 1876 there were just 39 whaleships left. Today there only is one.

Charles W. Morgan had been launched five years before the peak, in the winter of 1841—the same winter that a young sailor and teacher named Herman Melville boarded the whaler *Acushnet* just across the harbor for the voyage that would give him the basis for novels including *Moby-Dick*, a story in which the narrator describes sperm oil as "as rare as the milk of queens." *Charles W. Morgan* took her last whale on her 37th voyage in May 1921, only about 70 nautical miles off Virginia Beach.

Just about everyone aboard during this summer's 38th voyage had a copy of *Moby-Dick*. In my necessarily small kit, I carried two, as gifts to my grandchildren inscribed aboard a whaleship at sea.

And, although the oil burned in Buffalo long ago would keep safe inland-seas sailors who would never see a whale or salt water, I followed—symbolically, at least—those who did make the transition from lakes and canal to the brinier deep. Ishmael, in *Moby-Dick*, tells the dons of Lima, Peru, the story of the whaleship *Town-Ho* and its noble but rebellious sailor named Steelkilt, who leads a mass desertion after an encounter with the great white whale. Despite his origins on the shores of Lake Erie, he still is described by Ishmael as "wild-ocean

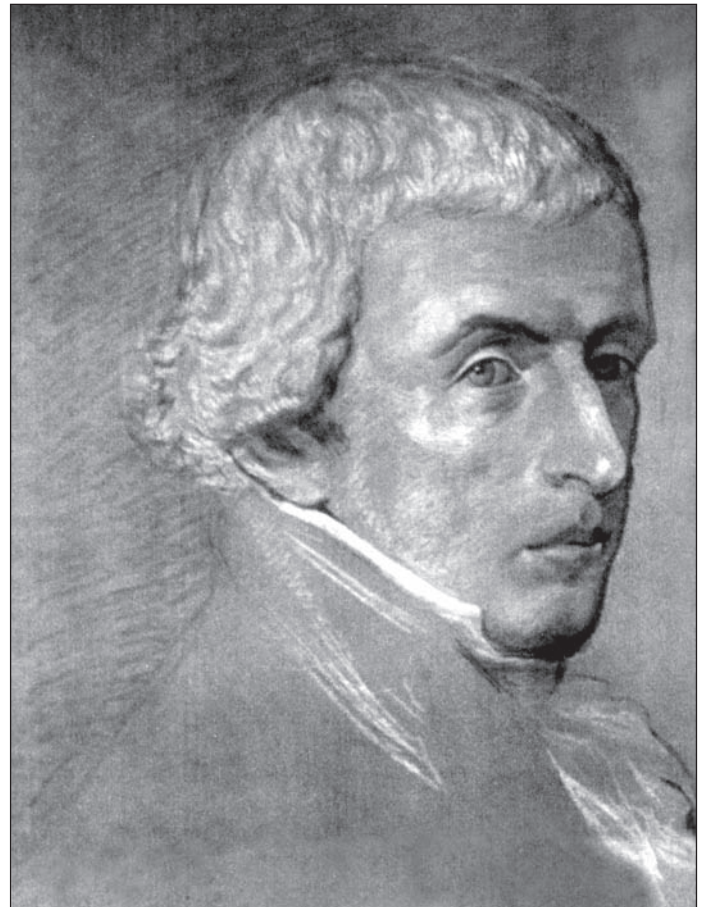

Ami Argand. USLHS archive image.

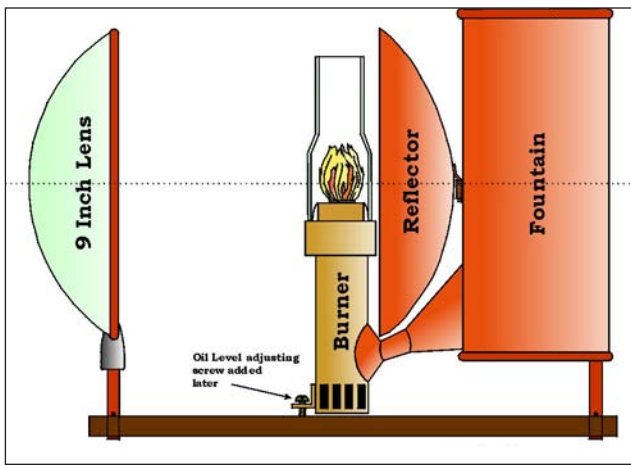

Winslow Lewis' original 1810 lamp with nine-inch reflector and nine-inch lens. USLHS archive image.

born,” and he is joined in his rebellion by two “canallers” who also had signed on for the hunt; years later, I would race J-27 yachts off Buffalo Harbor against a competitor who had named his boat *Steelkilt* in honor of yet another tie between the inland port and offshore whaling.

For this 38th ceremonial voyage, the whales were safe, despite some nervous joking about cetaceans with long memories. Some approached close aboard, spouting and fluking, during day sails from Provincetown to the marine sanctuary of the Stellwagen Bank. The *Charles W. Morgan* is a National Historic Landmark that sails now only for heritage and education and—like many lighthouses now—as a reminder of the maritime past that shapes our present and our future. Whaling and whale products were banned here by the Endangered Species Act of 1973 and have been curtailed in much of the world, except for native cultures and the sometimes-abused category of scientific research.

But whale exploitation is part of our past; indeed, it was an important part of our economic entry onto the world stage. And while lighthouses used only a fraction of the take, they at least provided an altruistic use for the whale's oil.

As early as 1803, sperm oil was arriving on the inland seas, far from the salt water oceans. A British army officer recorded the arrival of a lighthouse reflecting lamp and a supply of sperm oil at Fort George, in Canada near the Lake Ontario mouth of the Niagara River, in that summer. On April 18, 1818, Winslow Lewis wrote to the American commissioner of revenue, Samuel H. Smith, that the cost of shipping a 250-pound barrel of oil from Boston to Buffalo included 8 cents for “truckage and wharfage” in Boston, 75 cents for freighting from Boston to Albany, another 10 cents for truckage and wharfage in Albany, and \$11.25 for land carrying (the Erie Canal wasn't completed until 1825) from Albany to Buffalo, for a total of \$12.18 per barrel or \$4.50 per hundred pounds.

Buffalo's first lighthouse, lit in 1818 as one of the first two simultaneously built American lights on the Great Lakes, had nine lamps and reflectors, with an oil need calculated at 38 gallons per lamp, including a 15 percent allowance for leakage in transit. That meant the lighthouse, built about the same time Charles Waln Morgan began managing his first whaleship, would need 342 gallons, at a cost of \$17.48 in that year. In September, Lewis reported to Smith, 384

gallons of oil were consigned to the Buffalo Lighthouse and 430 to the Presque Isle, or Erie, Lighthouse, which had 10 lamps.

On May 28, 1820, keeper John Skaats informed Lewis that Buffalo Lighthouse had on hand 62 gallons of winter oil and 119 gallons of summer oil at the end of the previous year, and that he had received 10 barrels in January and had held the six intended for Presque Isle until the ice cleared and they could be shipped. His light's four barrels, he noted, contained 52 more gallons of winter oil and 61 of summer. One broken cask had leaked four gallons, which a wary Skaats took pains to document. By that point in the season, 10 gallons of oil already had been burned.

Keepers would have to cart the oil up stairs and ladders to reach the service rooms and lantern, the glassed-in tower top with the lens. Generally, they used five-gallon cans. Some accounts mention 80-pound loads, but it didn't all have to go up at once.

In May of 1842, with its new lighthouse about to finish its first decade, keeper Ramsdell had on hand 110 gallons of winter oil and 25 gallons of summer, and Superintendent of Lights William D. Wilson reported a Buffalo depot supply of almost 245 gallons of summer oil. A year later, Pleasanton would note a supply in storage at Chicago of 2,213 gallons of summer oil and 2,270 gallons of winter oil, which meant he would be ordering from Boston an additional supply of 4,514 gallons of summer oil and 2,270 gallons of winter oil for the four upper lakes (upstream from Niagara Falls, at that time a formidable navigation barrier between Lake Erie and lower Lake Ontario). He was basing the order on a calculation of 27 gallons per lamp, and chided Wilson on a discrepancy between the amount of oil signed for and the amount reported in storage, as well as expressing surprise that supplemental oil had been requested due to poor quality. The always watchful Pleasanton had had the oil tested and the sealed barrels branded, and he wanted to know if the casks in question were marked or not.

All that oil has gone up in flame (a very hot flame, as I once learned by passing my hand over the top vent of a lens lit by an oil lamp) and has been consigned to history. Whale and sperm oil have been replaced by other energy sources, synthetic lubricants, even better waxy oils from jojoba plant seeds. The whaling industry, at least in America, is no more. Even lighthouses now are lit with LEDs, in an era when navigation itself leans more heavily on satellites and radar.

But this summer, at least, the last of the great American whalers sailed past lighthouses from New London to Boston, on a journey that tied the past to the future.



Pine provision cask, possibly for use in whaleboat. Cask is painted gray, flaking to reveal light and dark blue undercoats. It is equipped with iron banding and an unusual swivel locking mechanism. It is attributed to New York's Hudson River Valley, mid-19th century. Courtesy of Mystic Seaport.

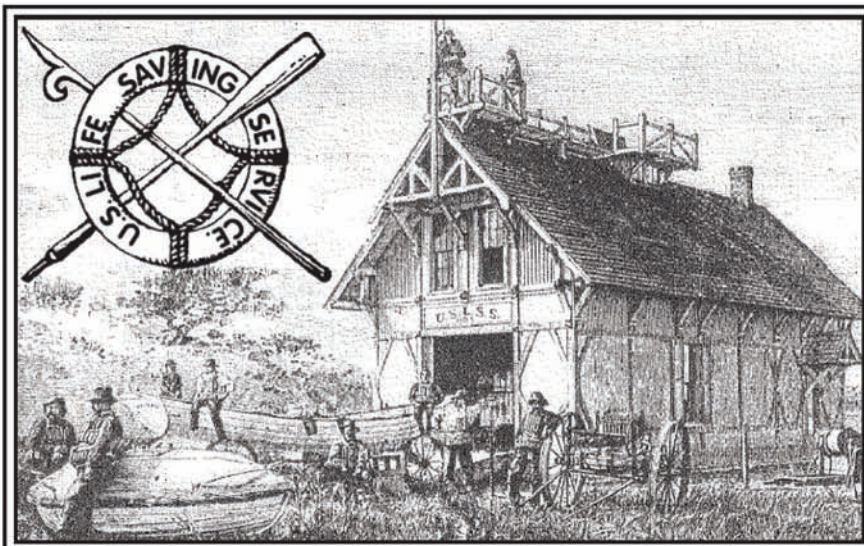

OUR SISTER SERVICE

The U. S. Life-Saving Service
1873 - 1915

Through Howling Gale and Raging Surf

By Dennis L. Noble

Reprinted from Vol. XII No. 3 (Spring 1996) and No. 4 (Summer 1996) Keeper's Log.



o most Americans, the United States Coast Guard is the service that saves lives. All of the various federal agencies brought together to form the modern day U.S. Coast Guard dealt in some manner with life-saving upon the waters or helping in the prevention of loss of life at sea. The primary mission of the U.S. Lighthouse Service, for example, was to maintain lighthouses and sea markers to warn ships from danger. Lighthouse keepers also helped those in distress near their stations. Each year the annual reports detailed rescues by keepers. Ida Lewis, the keeper of the Lime Rock lighthouse, for instance, won the Silver Life Saving Medal. The U.S. Revenue Cutter Service's primary duty was as a marine police force, but it also helped those in distress. Next, the Steamboat Inspection Service tried to prevent disasters before they happened. There was only one federal organization whose primary purpose was that of saving lives: the U.S. Life-Saving Service. In 1915, the U.S. Life-Saving Service and the U.S. Revenue Cutter Service would merge to form the U.S. Coast Guard.

The large numbers of shipwrecks along the eastern seaboard of the United States made many seek a way to help those in distress. New York's harbor is a good example of the need for shore-based help. A skipper of a 19th century wind-ship faced the chance of a winter nor'easter as he approached New York. The gale could force the ship ashore or onto one of the many New Jersey sandbars lying between 300 and 800 yards offshore. If a seagoing vessel tried to help, it also stood a good chance of grounding. Further, few people could withstand a 300-yard swim in the frigid Atlantic waters or the power of

the pounding surf. Even if they managed to survive a wreck, they would probably die of exposure on the deserted beaches before help arrived. On January 2, 1837, for example, the bark *Mexico* went ashore on the coast of New Jersey and all 112 emigrant passengers on board were lost. These factors pointed to the need for rescue from shore-based stations.

The beginning of the U.S. Life-Saving Service is usually set in Massachusetts. In 1807 the Massachusetts Humane Society established the first lifeboat station at Cohasset, Massachusetts. The Humane Society stocked small buildings with the equipment volunteers would need to help in a shipwreck. In 1848 New Jersey Congressman William A. Newell wrote an amendment to a lighthouse bill. Newell's plan released \$10,000 in federal funds to establish a series of small life-saving stations along the New Jersey coastline. Built and equipped by the federal government, the stations had volunteer crews, much like the Massachusetts Humane Society. No one, however, thought to incorporate a system of inspecting the stations. The units came under the loose control of the U.S.



Postcard image of U.S. Life-Saving crew in action on beach in Galveston, Texas. USLHS archive photo.

Revenue Marine (later called the U.S. Revenue Cutter Service) within the Treasury Department.

The federal life-saving effort during the two decades between 1848 and 1871 was erratic. On the plus side, the network of stations grew, eventually covering parts of the eastern seaboard and some location on the great lakes. The minus side, however, placed the idea of helping people shipwrecked close to shore in jeopardy. The basic problem centered on a lack of supervision of the stations. One town, for example, used the lifeboat assigned to it “as a trough for mixing mortar and a tub for scalding hogs.” In 1854 Congress voted funds to hire a man to remain at a station. The keeper still had to find volunteers to help in case of a wreck. Throughout the period stretching from 1848 to 1871, there was a series of shipwrecks, with large losses of life. Investigations reported poor performance by those at the federal life-saving stations. Newspapers began to demand a revamping of the life-saving network.

In 1871 a lawyer and a former politician from Maine, Sumner Increase Kimball, received the appointment to head the Revenue Marine Bureau within the Treasury Department. The life-saving stations were a part of Kimball’s responsibilities. The appointment marks the end of the volunteer era in federal life-saving in this country.

Kimball appointed Captain John Faunce of the U.S. Revenue Marine Service to inspect the life-saving network. His report painted a bleak picture. Equipment was “rusty for want of care,” and many keepers held their positions due to political influence. Discouraging as it was, the report served Kimball well. He took the report before Congress and received an appropriation of \$200,000. Kimball, using his organizational genius and political ability, then attacked the problems in Captain Faunce’s report. Kimball’s accomplishments over the next seven years are amazing. His efforts led to stations at new locations and the renovation of older units. Kimball wrote a set of regulations and set station routines. He also established physical standards for crews, hired paid crews, established a system of inspections and, in short, set the organization on the road to a professional service.

Kimball devised the personnel



Sumner Increase Kimball. U.S. Coast Guard photo.

system for the stations. The man in charge of a station was officially known as the keeper, although local newspapers gave him the title “Captain,” as did his crew. A keeper tended to have long experience at fishing or other maritime occupations or he worked his way through the ranks of the organization. He was expert at handling a small boat and had absolute control over the crew. The keeper resided at a station year round.

Crewmen received the title of surfman. The derivation of the name comes from the East Coast fishermen who rammed their boats into the surf from the beach. Surfmen signed articles of agreement to work for about nine months. Known as the “active season,” this was the time of the year

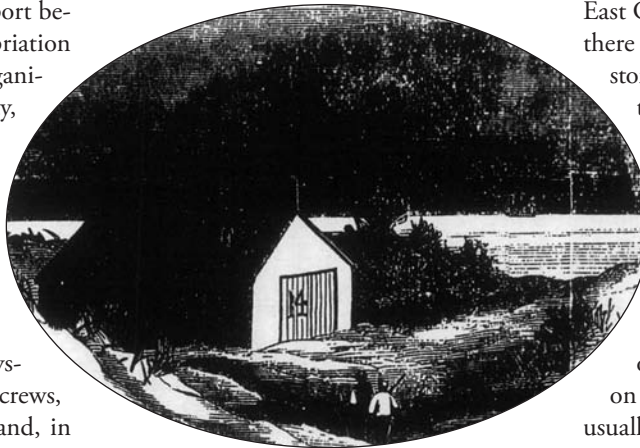

An early state life-saving station at Sandy Hook, New Jersey. USLHS archive image.

when wrecks were likely to occur. Surfmen could be no older than 45 and were adept at handling oars. Crew size depended on the number of oars needed to pull the largest boat on the unit. At most East Coast stations, this meant a crew of six. Experience decided the rank of surfmen. At East Coast stations, the number six surfman would be the least experienced and number one the most experienced and second in command. When the service became uniformed in 1889, surfmen wore their rank number on the left sleeve of their uniform jacket. The U.S. Life-Saving Service had neither a retirement nor a disability system. A keeper or a surfman could spend 20 years in the organization and, when unable to pass a physical, be forced to resign or cashiered with no pension.

The network of life-saving stations became a separate agency within the Treasury Department in 1878 and known as the U.S. Life-Saving Service. Stations dotted parts of the East, West, and Gulf coasts and the Great Lakes, with one unit at Nome, Alaska. Kimball became the general superintendent of the service. Rescuing those shipwrecked close to the shore was the only mission of this service.

It will be recalled that the stations of the Massachusetts Humane Society were huts stocked with blankets and equipment for volunteers in case of shipwreck. Once the federal government entered the picture, after 1848, stations were fitted out in basically the same manner. Then, in 1854, a man, called a keeper, remained at the station at all times and gathered volunteers in case of wreck near the unit.

Kimball’s new service had three classes of stations. At isolated locations along the East Coast and portions of the Great Lakes, there were life-saving stations, usually two-story buildings with full crews only during the “active season.” There was enough room in the structures to temporarily house shipwrecked persons. The boathouse doors opened towards the sea and a ramp led to the beach. The surfboat was the primary craft used at these stations for rescue. Usually boats and other equipment were on the ground floor and the crew slept on the second floor. Life-saving stations usually had a keeper and six surfmen.

The next class, lifeboat stations, were usually located on the Great Lakes and the West Coast. At these

locations, most shipwrecks occurred near the harbor's entrance and the stations usually sat near the entrance to the harbor. The main rescue craft at these story-and-a-half buildings was the heavy lifeboat, launched down an inclined ramp directly into the water. Originally, only the keeper resided year round at the station. He rounded up volunteers in case of a wreck. As time went on, however, even the lifeboat stations on the Great Lakes kept paid crews on site for the entire "active season." Eventually, the stations on the West Coast became the only units in the service to be fully operational year round. A lifeboat station usually had a keeper and eight surfmen. It is important to keep in mind that, in general, service for the surfmen, except on the West Coast, was part-time.

By regulations, only the keeper and his family could live on the station. A married surfman at an isolated unit wishing to have his wife nearby had to build a dwelling away from the property line of the station.

The U.S. Life-Saving Service had an entirely different type of unit in Georgia, South Carolina, and portions of Florida. In this region, the service felt if a shipwreck oc-

curred, sailors did not face death from their ships slamming and breaking into pieces on cold beaches. The ships would usually "come up almost high and dry, rendering comparatively easy the escape of their crews." Their greatest danger was "to perish from hunger and thirst." These one story units, known as houses of refuge, could house up to 25 survivors, with provisions for 10 days. Instead of glass, the windows were "fitted with wire-gauze mosquito netting." Houses of refuge had a keeper and his family, who would patrol the beaches after a storm.

Kimball is the reason that the United States gained a reputation for a professional life-saving service. The bill to establish the U.S. Coast Guard provided for the retirement of Kimball. A small dose of statistics suggests what Kimball accomplished. From 1871 through 1914, "28,121 vessels and 178,741 persons became involved with its services." Only "1,455 individuals lost their lives while exposed within the scope of Life-Saving operations." This nation owes a great debt to Kimball, the little-known man who organized and ran a service that did so much for those in peril upon the sea.

The U.S. Life-Saving Service had two means of rescuing those on board ships stranded near shore: by boat and by a strong line stretched from the beach to the wrecked vessel. At the time of the establishment of the U.S. Life-Saving Service (1878), the accepted method of rescuing those stranded near the beach was by small boats powered by oars. The principal power of ships was still the wind, and any windjammer trying to help a ship stranded near the beach stood a good chance of also running aground, especially if there were strong onshore winds.

The service used two types of boats for rescue work. The boat most used was the surfboat. Surfboats are generally light, open, shallow-draft craft, usually between 20 and 27 feet in length and able to be launched directly from the beach into the surf. The boat meant that the boathouse doors of the station opened out onto the beach facing the sea. Because the surfboat was not heavy, it could be drug over the beach by hand or on rollers. The boat could also be pulled by the surfmen or by horses on a carriage over the sandy terrain of much of the East Coast. Most importantly, the boat was easy for



An 1880s design of a Life-Saving Service Station at north Manitou Island in Lake Michigan. Early station designs had an open platform for the watch stander. In this design, the watch room is enclosed. Note the watchman on the balcony and the small children in front of the marine railway. USLHS archive photo.

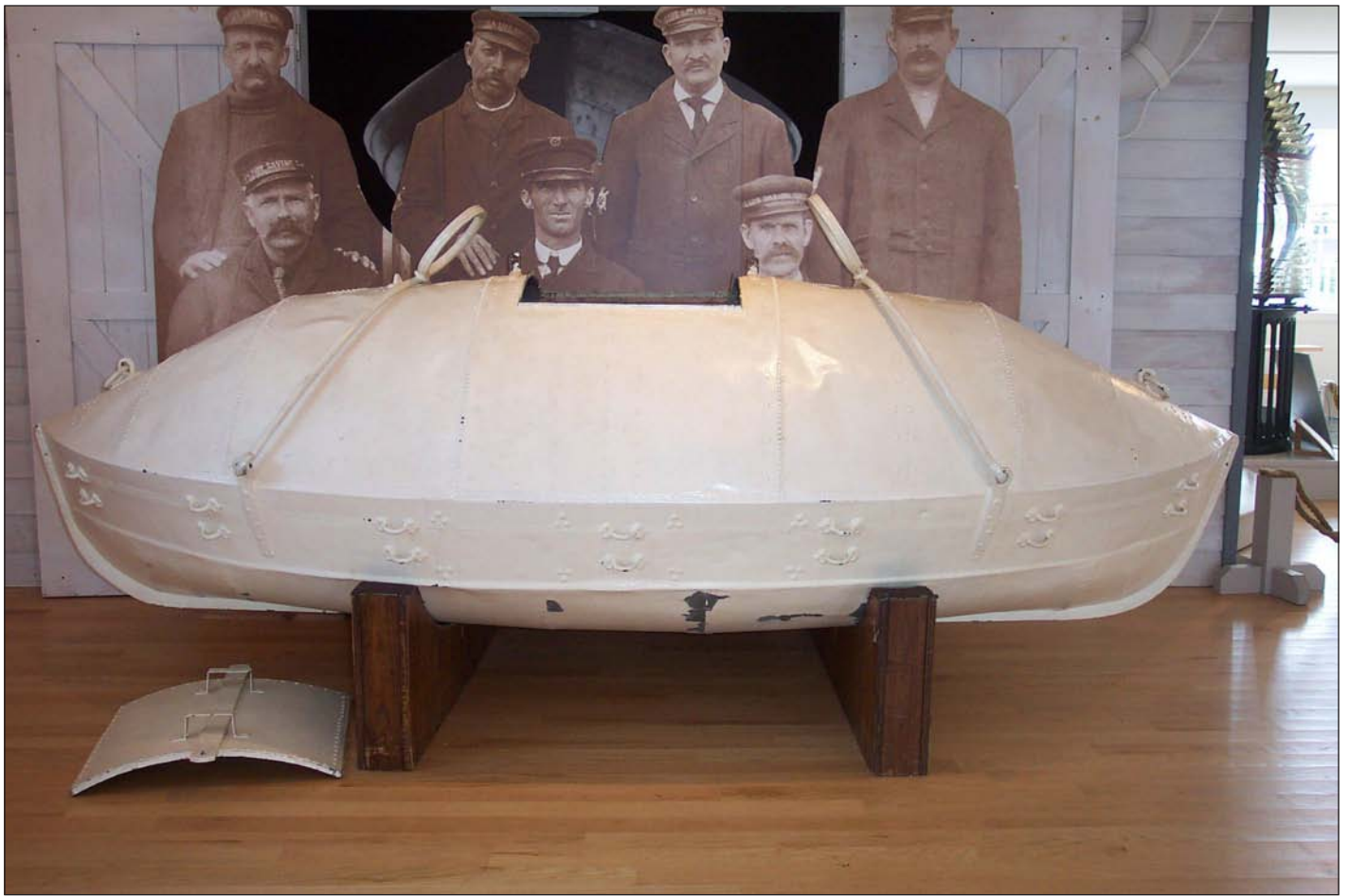

A life car on display at Tuckerton Seaport in New Jersey. USLHS archive photo.

small crews to handle, maneuverable, and performed well in short pulls in heavy surf.

In the early years of the service, there was no standardized surfboat. The boat builders of each coastal region were watermen who provided modifications to meet the needs of their local area. In 1872 Captain Robert B. Forbes of the Massachusetts Humane Society wrote that he could not recommend any one type of boat that would be successful in New Jersey, Long Island, Nantucket, Cape Cod, or other locations. Captain Forbes felt that watermen in these areas had their “own ideas” as to the type of craft “they require when they are to risk their lives to save lives and property.” A very general description of these versatile boats would be a craft between 700 to 1,000 pounds, self-bailing, self-righting, and pulled by six surfmen with 12- to 18-foot oars. As mentioned, the surfboat could be pulled on a cart by crewmen or horses to a site near a wreck and then launched into the surf.

The second boat employed by the service for rescue was the coastal lifeboat—simply called a

lifeboat. The craft followed a design that originated in England. The boat could be fitted with sails for work farther offshore and was used in very heavy weather. In June 1873, the first English lifeboat was tested in this country. The boat was 30 feet in overall length, with large air chambers at the bow and stern. A heavy iron keel provided the self-righting capability. This was a boat that could weigh into the tons and required a crew of eight. Obviously this was not the type of craft that surfmen on the East Coast could easily put on a carriage and pull across the sandy beaches. The boat eventually served mostly on the Great Lakes and the West Coast where it could be launched directly into the water on a carriage running on an inclined ramp. Some crews on the Great Lakes, at first, viewed the lifeboat with skepticism because of its weight. The skepticism soon changed, and crews began to regard it as “something almost supernatural,” for it enabled them to provide assistance “when the most powerful tugs and steam craft refused to go out of the harbor.”

The surfboat, however, remained the favor-

ite of the life-saving crews, even at stations that had lifeboats. In the 1882 annual report of the U.S. Life Saving Service, for example, the service reported that the surfboat had been used 284 times, making 381 trips, while the lifeboat was used only 11 times, making 15 trips.

One of the reasons for the success of the U.S. Life-Saving Service was the systematic routine devised for the stations. The service placed great emphasis on drilling (practicing) constantly with their rescue equipment. Regulations required the crews to drill with their boats on Tuesday.

Rescue by small boats was the least complicated method of rescue, but also the most dangerous. The first danger was the power of the pounding surf. It was not unusual for crews to put out into seas many times higher than the length of their small boats. (It is amazing to stop and recall that no boat used by the service was longer than 36 feet in length.) Another danger came at the actual moment of rescue. Maneuvering a rolling,

pitching small boat alongside a larger vessel with broken spars, lines, and other debris nearby, required a large amount of skill in boatmanship and the ability to think fast and improvise. Drills helped the crews work as a team and automatically perform their functions, all of which could pay large dividends when the winds were at gale force and the surf pounding the beach.

The weekly practice required the surfmen to actually launch a surfboat from the cart into the surf and then land it. This is known as open beach launchings, one of the most difficult methods of putting a boat into the water. One portion of the drill involved actually capsizing and righting the boat. This trained crews to react automatically if their boat was flipped in a storm. In 1912 Noel T. Methley, an authority on lifeboats, noted the constant practice enabled the lifesavers to completely right the surfboat after capsizing in “twenty seconds.” The capsizing drill was a popular show for the public, and the surfmen performed it at many public events. In 1890, for example, the Marquette, Michigan, newspaper wrote that the most impressive event at the Fourth of July festivities was the lifeboat drill. The newspaper reported the “crews capsized it eight times... to the repeated cheers of the crowd.” How cheerful the crew felt about being dunked into the frigid waters of Lake Superior is not recorded.

When the crews put out to sea in their craft to do battle with the sea, they took very little equipment with them. The men would wear cork lifejackets and, if the weather was very foul, they might don oilskins. The service experimented briefly with a rubber suit almost like a survival wetsuit, but it was not popular with the surfmen and went out of use. The lifeboats would carry some extra line for towing, a life ring, and that was about it. It was muscle, oars, courage, and very little else.

When a ship wrecked close to shore and the seas were too rough even for boats, then the service could use another method to reach the stranded mariners by stringing a strong hawser (line) from the shore to the ship. From time immemorial, people experimented with ways to propel a line from shore to a ship wrecked near the beach. Experiments with arrows and kites were attempted. Eventually, Captain George Manby, a British Merchant Marine officer, developed a mortar

to it that would be used to establish a stronger line to a ship in distress. Line-carrying rockets were perfected. It was Lieutenant David Lyle of the U.S. Army's Ordinance Department that developed the line-throwing gun used by the U.S. Life-Saving Service. Lieutenant Lyle would later say that his device was a direct descendent of the Manby mortar.



Lyle gun on display at Portland Head Lighthouse, Maine. USLHS archive photo.

The Lyle gun was made of brass, weighed 163 pounds, and looked like a miniature cannon. The Lyle gun was mounted in a wooden iron-bound oak carriage. For elevation settings, there was a notched wooden block. To carry the line to a ship, black powder was loaded into the gun, and then a metal projectile, called a shot, was placed inside the barrel. The projectile is best described as a “sash-weight-with-eye-bolt.” The end of the eye bolt remained outside of the cannon, with the messenger line tied to the eye bolt. When fired, the shot turned in the air and pulled the light messenger line to the shipwreck. Although longer ranges could be obtained, Lyle felt 600 yards was the limit a hawser could be stretched from the shore to a ship. Lyle preferred accuracy to extreme long range.

The shipwrecked sailors would gather the light messenger line shot over by the Lyle gun and then use that line to pull over heavier lines until a very strong rope bridge with a thick hawser was established between a ship and shore. Once the rope bridge was secure, the lifesavers had a choice of sending one of two devices on the hawser.

A life car could be pulled back and forth between the wreck and the safety of the shore by the lifesavers. The life car looked like a tiny, primitive submarine. The life car could be hauled over, through, or even under the seas. After the hatch in the top

of the car was sealed, there was enough air within the device to hold 11 people for three minutes. It is hard to envision 11 people crowding into the car's small compartment but, as one surfman put it, people “... in that extremity are not apt to stand on the order of their going.”

Typically, a life car carried four to six people. Life cars were heavy and difficult to handle. Also, as those in distress evolved from crowded immigrant packets with many on board to small commercial schooners with less than a dozen on board, the life car was replaced by a second device that could be sent along the hawser: the breeches buoy.

A breeches buoy resembles a life preserver ring with canvas pants attached. It could be pulled out to the ship by the lifesavers using pulleys, enabling the endangered sailor to step into the life ring and pants and then be pulled to safety much easier than the heavier life car. A cart with wide metal wheels carried all the equipment needed to rig the breeches buoy and could be pulled by the crew or horses to the wreck site. The wide metal wheels were designed to prevent the cart from sinking in the soft beach sand. The cart carrying the ropes and equipment for rigging either the breeches buoy or life car became known as the beach apparatus.

The use of the beach apparatus was the most difficult method of rescuing people from ships wrecked close to the beach. Therefore, Mondays and Thursdays were devoted to practicing with the gear. Drilling included the actual firing of the Lyle gun and rigging the equipment. The aiming point for this drill was a pole, sometimes shaped like a ship's mast and known as the drill pole, located on or near the grounds of each station. When the district inspector tested the crews on the beach



Lyle gun on cart, ready to go. USLHS archive photo.



Breeches buoy on display at the Michigan Maritime Museum. USLHS archive photo.

apparatus, the entire routine had to be finished within five minutes. If the drill could not be finished within the allotted time, the men slowing the drill could be dismissed from the service. The constant practice, again, built skill and also a confidence factor that many times would be tested on stormy nights along a dark and cold beach. For example, the messenger line had a tendency to snap if too wet. It takes a great deal of confidence, and reacting automatically, to start everything over when you are wet and cold and discouraged.

Drill periods, however, did not always go smoothly as prescribed by regulations. A Michigan City, Indiana, keeper wrote in his logbook after a beach apparatus: "Projectile... lost in lake, through the fault of Thomas Armstrong not making shot [line] fast to shot." On a Tuesday, the same keeper recorded: "Surfmen Parsons and Miller... were thrown into the lake [while] steering [sic] the boat." At Coquille River, Oregon, surfman Axel Sandstorm confided in his diary that, during boat drill, "we took a big swell that put our boat right on end.

The Captain [keeper] got slung out of his position and the steering oar broke, so we went home again just a little wet."

Boat drill could also be dangerous. In 1886 the keeper and two surfmen at Coquille River were drowned when struck by a rogue wave at the entrance to the river. At least three surfmen were killed during boat drills at the Point Reyes, California, station.

Both pulling boats and beach apparatus were eventually replaced by changing technology, although some equipment remained for a remarkably long time. In 1899 the service began to evaluate the results of installing a gasoline 12-horsepower engine in a 34-foot *Merryman* lifeboat at Marquette, Michigan. Eventually, but after the end of the U.S. Life-Saving Service in 1915, all lifeboats and surfboats would be mechanically propelled.

Technology also spelled the end of the beach apparatus. Once ships became steam powered, they were able to stay much farther offshore and the need for the beach apparatus diminished. The beach apparatus, however, remained at stations along the Great Lakes through the 1950s. Helping to speed the demise of the beach apparatus was the development of the helicopter as a rescue tool.

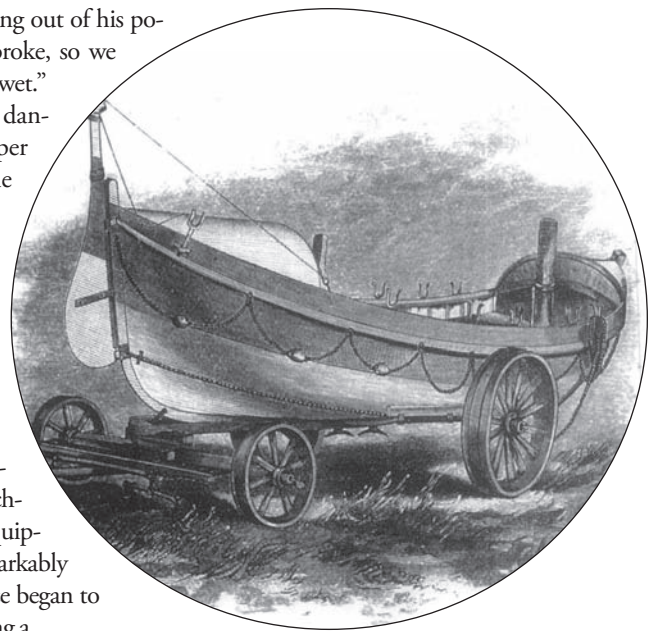

The heavy self-righting surf boat. USLHS archive image.

Although the U.S. Life-Saving Service employed what we would now call low technology to rescue people from shipwrecks close to shore, the equipment they used was the best available. The boats and beach apparatus, combined with the crew's natural skills, their innate courage, and the confidence instilled in them through drills, helped save many lives that would surely have been lost to the sea.

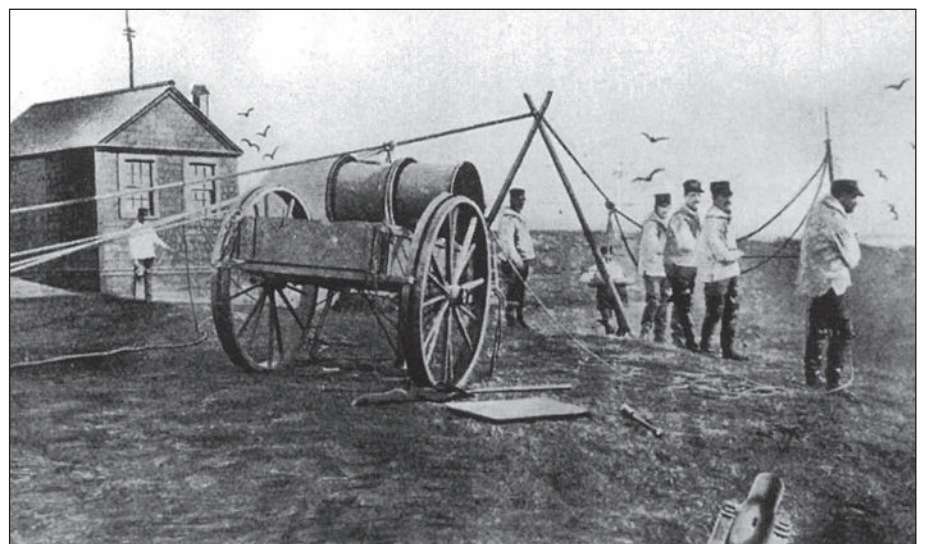

A beach cart in use during a line throwing drill. Note the Lyle gun lower right. USLHS archive photo.



A MATCHING GIFT MEANS YOUR CONTRIBUTION WILL GO TWICE AS FAR.

Many companies will double (or sometimes triple) the value of their employees' gifts to the U.S. Lighthouse Society. These matching gifts provide valuable funds as we work to fulfill our mission to educate and inform people on the importance of preserving our nation's lighthouses.

To see if your company will match a gift to the U.S. Lighthouse Society, visit http://www.uslhs.org/assets/companies_that_offer_matching_gifts.pdf, contact headquarters at (415) 362-7255, or contact your human resources department.

NOTICE TO KEEPERS

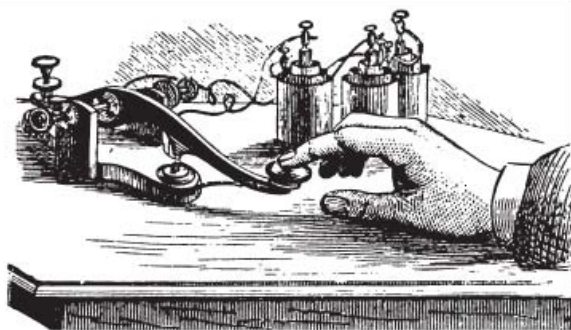

In Honor of the Society's 30th Anniversary:

Above: At the soft opening of the National Lighthouse Museum, Wayne Wheeler (center) was presented with the "Modern Day Light Keeper Award" recognizing the 30th anniversary of the U.S. Lighthouse Society. Photo by Ralph Eshelman.

Left: Land's End generously donated \$30,000 to the U.S. Lighthouse Society Lighthouse Preservation Fund, \$10,000 of which was in turn donated to Block Island Southeast Lighthouse, the first recipient of the Society's new lighthouse grant program. Marla Ryan, senior vice president, Land's End (center), presents the check to Executive Director Jeff Gales (left) and Society Vice-President Henry Gonzalez (far right) during ceremony at Block Island Southeast Lighthouse. Photo courtesy of Jeff Gales.

USLHS Tours . . .

A Better Way To See Lighthouses!



U.S. Lighthouse Society Tours are fun, stimulating adventures designed to captivate our members. Our routes are specifically developed to maximize not only lighthouse touring, but also to help you gain a better understanding of the culture and communities in which lighthouses are located. Historic landmarks and other cultural sites, cruises and museums are often included as part of our itineraries and when possible, free time is provided so you can explore personal interests.

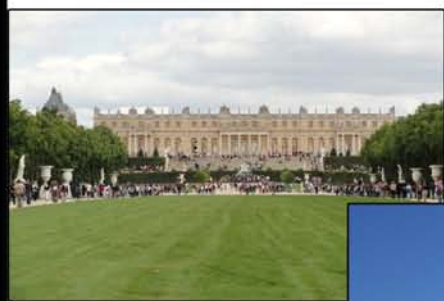

Join one of our exciting tours today!

For detailed itineraries see the Society's website: www.uslhs.org
or contact headquarters at 415-362-7255 for a printed copy



TOWER FOR

MONHEGAN LIGHT

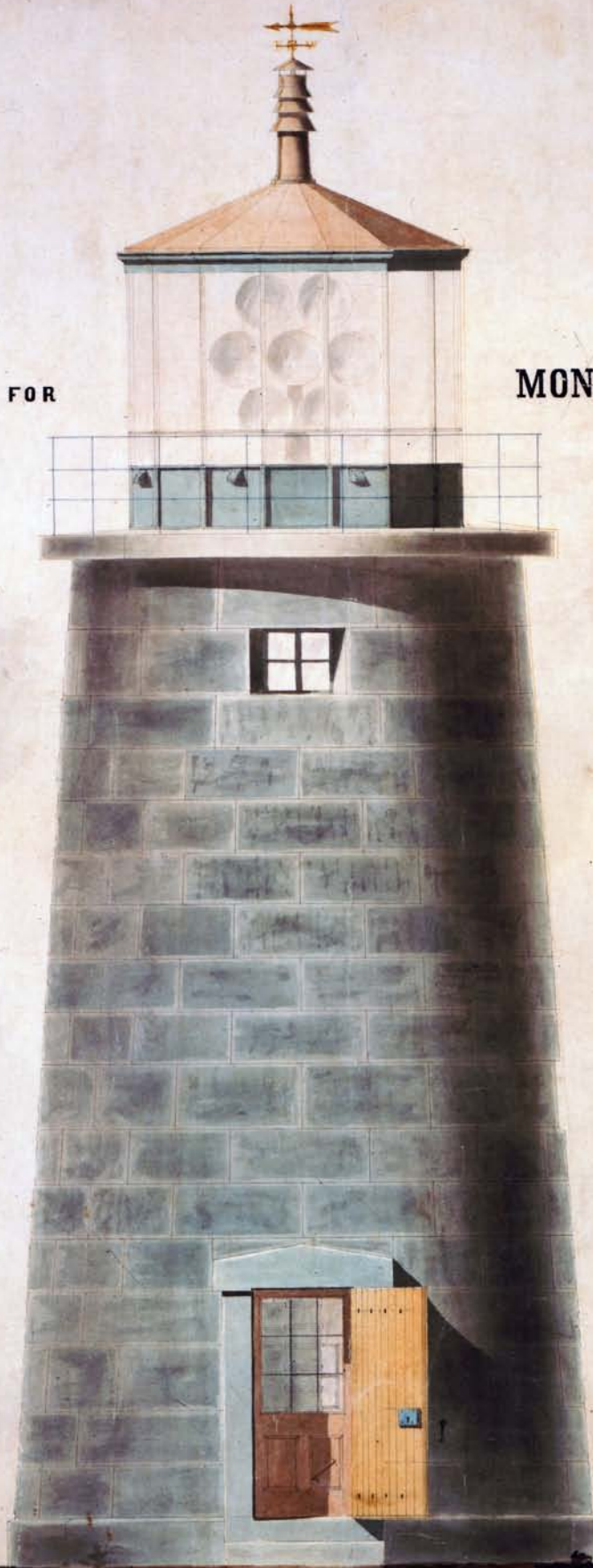

Dist.

1-9M5

1849.